



**COMMITTEE DRAFT OIML/CD5**

Date: 17 ~~August~~ **September** 2010

Deleted: August

Reference number: **OIML/TC12/5**

Comment [p1]: This draft has been updated since the draft dated 17 August 2010 to include 6.4.17 Durability test).

Supersedes document: OIML TC12/WG1/4

**OIML TC 12**

Title: **Active Electrical Energy Meters**

Secretariat: **Australia**

Circulated to P- and O-members and liaison international bodies and external organizations for:

- discussion at (date and place of meeting): .....
- comments by: 30 November 2010
- vote (P-members only) and comments by .....

TITLE OF THE CD (English):

OIML R 46-1 and -2

**Active Electrical Energy Meters**

Part 1: Metrological and Technical Requirements

Part 2: Metrological controls and performance tests

TITRLE DU CD (French):

OIML R 46-1 et -2

**Active Electrical Energy Meters**

Partie 1: Exigences métrologiques et techniques,

Partie 2: Contrôles métrologiques et essais de performance

Original version in: English

Deleted: R46CD5 (30 July 2010)

# Contents

1	Scope .....	8
2	Terminology .....	8
2.1	Meters and their constituents .....	8
2.1.1	Electricity meter .....	8
2.1.2	Interval meter .....	8
2.1.3	Prepayment meter .....	8
2.1.4	Multi-tariff meter, multi-rate meter .....	8
2.1.5	Direct connected meter .....	8
2.1.6	Transformer operated meter .....	8
2.1.7	Electromechanical meter .....	8
2.1.8	Static meter .....	8
2.1.9	Measuring element .....	8
2.1.10	Current circuit .....	8
2.1.11	Voltage circuit .....	9
2.1.12	Indicating device, display .....	9
2.1.13	Register .....	9
2.1.14	Primary rated register .....	9
2.1.15	Register multiplier .....	9
2.1.16	Meter constant .....	9
2.1.17	Test output .....	9
2.1.18	Adjustment device .....	9
2.1.19	Auxiliary device .....	9
2.2	Metrological characteristics .....	9
2.2.1	Current ( $I$ ) .....	9
2.2.2	Starting current ( $I_{st}$ ) .....	9
2.2.3	Minimum current ( $I_{min}$ ) .....	9
2.2.4	Transitional current ( $I_t$ ) .....	9
2.2.5	Maximum current ( $I_{max}$ ) .....	9
2.2.6	Voltage ( $U$ ) .....	9
2.2.7	Nominal voltage ( $U_{nom}$ ) .....	10
2.2.8	Frequency ( $f$ ) .....	10
2.2.9	Nominal frequency ( $f_{nom}$ ) .....	10
2.2.10	Harmonic .....	10
2.2.11	Sub-harmonic .....	10
2.2.12	Harmonic number .....	10
2.2.13	Distortion factor ( $d$ ) .....	10
2.2.14	Power factor (PF) .....	10
2.2.15	Active power .....	10
2.2.16	Active energy .....	10
2.2.17	Relative error (of indication) .....	10
2.2.18	Maximum permissible error (m.p.e.) .....	11
2.2.19	Base maximum permissible error .....	11
2.2.20	Maximum permissible error shift .....	11
2.2.21	Intrinsic error .....	11
2.2.22	Initial intrinsic error .....	11
2.2.23	Influence quantity .....	11
2.2.24	Influence factor .....	11
2.2.25	Disturbance .....	11

2.2.26	Rated operating condition	11
2.2.27	Reference condition	11
2.2.28	Accuracy class	11
2.2.29	Durability	11
2.2.30	Fault	11
2.2.31	Significant fault	12
2.2.32	Checking facility	12
2.2.33	Primary Register	12
3	Metrological Requirements	12
3.1	Units of measurement	12
3.2	Rated operating conditions	12
3.3	Accuracy requirements	13
3.3.1	General	13
3.3.2	Direction of energy flow	14
3.3.3	Maximum permissible errors	14
3.3.4	Allowed effects of influences	15
3.3.5	Allowed effects of disturbances	16
3.3.5.1	General	16
3.3.5.2	Disturbances	16
3.4	Timing requirements for interval and multi-tariff meters	18
3.5	Meter Markings	18
3.6	Protection of metrological properties	19
3.6.1	General	19
3.6.2	Software identification	19
3.6.3	Software protection	19
3.6.3.1	Prevention of misuse	19
3.6.3.2	Fraud protection	19
3.6.4	Parameter protection	20
3.6.5	Separation of electronic devices and sub-assemblies	20
3.6.6	Separation of software parts	21
3.6.7	Storage of data, transmission via communication systems	21
3.6.7.1	General	21
3.6.7.2	Automatic storing	21
3.6.7.3	Data transmission	22
3.6.7.4	Time stamp	22
3.6.8	Checking facility event record	22
3.7	Suitability for use	22
3.7.1	Readability of result	22
3.7.2	Testability	22
3.8	Durability	22
3.9	Presumption of compliance	23
4	Type approval	24
4.1	Documentation	24
4.2	Type definition	25
4.2.1	Type test sampling	25
4.3	Validation Procedure	25
5	Test program	26
6	Test procedures for type approval	26
6.1	Test conditions	26

6.2	Tests for maximum permissible error.....	27
6.2.1	Determination of initial intrinsic error.....	27
6.2.2	Continuous maximum current.....	28
6.2.3	Starting current.....	28
6.2.4	Test of no-load condition.....	29
6.2.5	Meter constants.....	29
6.3	Tests for influence quantities.....	29
6.3.1	General.....	29
6.3.2	Temperature dependence.....	29
6.3.3	Load balance.....	30
6.3.4	Voltage variation.....	30
6.3.5	Frequency variation.....	30
6.3.6	Harmonics in voltage and current.....	30
6.3.7	Tilt.....	32
6.3.8	Severe voltage variations.....	32
6.3.9	One or two phases interrupted.....	32
6.3.10	Sub-harmonics in the AC current circuit.....	33
6.3.11	Harmonics in the AC current circuit.....	34
6.3.12	Reversed phase sequence (any two phases interchanged).....	34
6.3.13	Continuous (DC) magnetic induction of external origin.....	35
6.3.14	Magnetic field (AC, power frequency) of external origin.....	35
6.3.15	Electromagnetic fields.....	35
	6.3.15.1 Radiated, radio frequency (RF), electromagnetic fields.....	35
	6.3.15.2 Immunity to Conducted Disturbances, Induced by Radiofrequency Fields.....	36
6.3.16	DC in the AC current circuit.....	37
6.3.17	High-order harmonics.....	37
6.4	Tests for disturbances.....	37
6.4.1	General instructions for disturbance tests.....	37
6.4.2	Magnetic field (AC, power frequency) of external origin.....	38
6.4.3	Electrostatic discharge.....	38
6.4.4	Fast transients.....	38
6.4.5	Voltage dips and interruptions.....	39
6.4.6	Radiated, radio frequency (RF), electromagnetic fields.....	40
6.4.7	Surges on AC mains power lines.....	40
6.4.8	Damped oscillatory waves immunity test.....	40
6.4.9	Short-time overcurrent.....	41
6.4.10	Impulse voltage.....	41
	6.4.10.1 General.....	41
	6.4.10.2 Impulse Voltage Test Procedure.....	42
	6.4.10.3 Impulse voltage tests for circuits and between circuits.....	42
	6.4.10.4 Impulse voltage test of electric circuits relative to earth.....	43
6.4.11	Earth fault.....	43
6.4.12	Operation of auxiliary devices.....	43
6.4.13	Mechanical tests.....	44
	6.4.13.1 Vibrations.....	44
	6.4.13.2 Shock.....	44
6.4.14	Protection against solar radiation.....	44
6.4.15	Protection against ingress of dust.....	45
6.4.16	Climatic tests.....	45
	6.4.16.1 Extreme temperatures - dry heat.....	45

6.4.16.2	Extreme temperatures - cold	45
6.4.16.3	Damp heat, steady-state (non-condensing), for humidity class H1	46
6.4.16.4	Damp heat, cyclic (condensing) for humidity class H2 and H3	46
6.4.16.5	Water test	47
6.4.17	Durability test	47
7	Examination for conformity with type	48
8	VERIFICATION	48
8.1	General	48
8.2	Testing	49
8.2.1	Calibration status	49
8.2.2	Conformity check	49
8.2.3	Warming-up	49
8.2.4	Minimum test programme	49
8.2.4.1	No-load check	49
8.2.4.2	Starting current check	49
8.2.4.3	Current dependence	50
8.2.4.4	Check of the register	50
8.2.5	Sealing	50
8.3	Reference conditions for initial and subsequent verifications in a laboratory	50
8.4	Additional requirements for statistical verifications	51
8.4.1	Lot	51
8.4.2	Samples	51
8.4.3	Statistical testing	51
8.5	Additional requirements for statistical in-service inspections	51
Annex A	Definitions Taken From Other References	52
A.1	Note on application of definitions	52
A.2	Definitions from VIM:2007 (3 <sup>rd</sup> edition) [2]	52
A.2.1	Maximum permissible error [4.26]	52
A.2.2	Rated operating condition [4.9]	52
A.2.3	Reference condition [4.11]	52
A.2.4	Accuracy class [4.25]	52
A.3	Definitions from VIM:1993 (2 <sup>nd</sup> edition) [3]	52
A.3.1	Intrinsic Error [5.24]	52
A.3.2	Influence quantity [2.7]	52
Annex B	Bibliography	53
Annex C	Estimation of Errors and Uncertainties	59
C.1	Estimate of overall maximum probable uncertainty	59
C.1.1	Estimation based on the requirements of this Recommendation	59
C.1.2	Estimation based on type test results and specific conditions	59
Annex D	Legislative Matters	61
D.1	Legislative considerations	61
D.1.1	Choice of accuracy class	61
D.1.2	Matters not covered by the scope of this document	62

<b>Deleted:</b>	1	Scope	8¶
2	Terminology	8¶	
2.1	Meters and their constituents	8¶	
2.1.1	Electricity meter	8¶	
2.1.2	Interval meter	8¶	
2.1.3	Prepayment meter	8¶	
2.1.4	Multi-tariff meter, multi-rate meter	8¶	
2.1.5	Direct connected meter	8¶	
2.1.6	Transformer operated meter	8¶	
2.1.7	Electromechanical meter	8¶	
2.1.8	Static meter	8¶	
2.1.9	Measuring element	8¶	
2.1.10	Current circuit	8¶	
2.1.11	Voltage circuit	9¶	
2.1.12	Indicating device, display	9¶	
2.1.13	Register	9¶	
2.1.14	Primary rated register	9¶	
2.1.15	Register multiplier	9¶	
2.1.16	Meter constant	9¶	
2.1.17	Test output	9¶	
2.1.18	Adjustment device	9¶	
2.1.19	Auxiliary device	9¶	
2.2	Metrological characteristics	9¶	
2.2.1	Current ( $I$ )	9¶	
2.2.2	Starting current ( $I_s$ )	9¶	
2.2.3	Minimum current ( $I_{min}$ )	9¶	
2.2.4	Transitional current ( $I_t$ )	9¶	
2.2.5	Maximum current ( $I_{max}$ )	9¶	
2.2.6	Voltage ( $U$ )	9¶	
2.2.7	Nominal voltage ( $U_{nom}$ )	10¶	
2.2.8	Frequency ( $f$ )	10¶	
2.2.9	Nominal frequency ( $f_{nom}$ )	10¶	
2.2.10	Harmonic	10¶	
2.2.11	Sub-harmonic	10¶	
2.2.12	Harmonic number	10¶	
2.2.13	Distortion factor ( $d$ )	10¶	
2.2.14	Power factor (PF)	10¶	
2.2.15	Active power	10¶	
2.2.16	Active energy	10¶	
2.2.17	Relative error (of indication)	10¶	
2.2.18	Maximum permissible error (m.p.e.)	11¶	
2.2.19	Base maximum permissible error	11¶	
2.2.20	Maximum permissible error shift	11¶	
2.2.21	Intrinsic error	11¶	
2.2.22	Initial intrinsic error	11¶	
2.2.23	Influence quantity	11¶	
2.2.24	Influence factor	11¶	
2.2.25	Disturbance	11¶	
2.2.26	Rated operating condition	11¶	
2.2.27	Reference condition	11¶	
2.2.28	Accuracy class	11¶	
2.2.29	Durability	11¶	
2.2.30	Fault	11¶	
2.2.31	Significant fault	12¶	
2.2.32	Checking facility	12¶	
2.2.33	Primary Register	12¶	
3	Metrological Requirements	12¶	
3.1	Units of measurement	12¶	
3.2	Rated operating conditions	12¶	
3.3	Accuracy requirements	14¶	
3.3.1	General	14¶	
3.3.2	Direction of energy flow	14¶	
3.3.3	Maximum permissible error	14¶	

**Deleted:** R46CD5 (30 July 2010)

## Explanatory Note

The former OIML Recommendation IR-46 “ACTIVE ELECTRICAL ENERGY METERS FOR DIRECT CONNECTION (CLASS 2)” was withdrawn by the CIML in 1997, because it was inconsistent with existing IEC standards and the metering technology development had made it outdated. Within OIML TC 12 a working group for the revision of the IR 46 has been formed, with members from most parts of the world, to ensure that the revised recommendation attains a wide acceptance.

In the absence of an updated OIML Recommendation, the electricity meters are presently tested against IEC standards or national or regional standards. A revised OIML Recommendation could be accepted in most parts of the world, therefore reducing costs for manufacturers, nations and consumers. Although the drafted Recommendation is closely aligned with IEC standards, it is neither possible nor desirable to adopt IEC tests or requirements in every case because the IEC standards for electricity meters are technology-dependent and, in the case of electromechanical meters, rather old. In addition, IEC standards are not used in some parts of the world. Furthermore, it is important that the OIML Recommendation reflects the changing demands of legislation and protects consumer interests.

With newer technology, including static meters and software control, the variation within a “type” is much larger and “meter type” is harder to define. OIML must address the extent to which a meter can be changed without the necessity for a new type test, and how software can be tested and secured. EMC, integrity and functionality have also become much more important issues.

The OIML TC12 working group for the revision of IR 46 started its work at a meeting in Borås, Sweden, in September 2002, where task-groups were formed for different parts of the standardisation work. An Internet workplace was set up. This is a restricted-access web-site where the working group members can freely download information and download, change and upload working documents. The input from the different task-groups was collected to a pre-draft that was discussed during the second meeting, which was held in Maastricht, March 27-28.

In Maastricht, most of the items in the pre-draft were discussed and decided upon or left for further work. The discussions were mainly about two topics: how to define the accuracy requirements and the level of allowed effects of influence quantities. There are quite a few influence quantities that could affect the accuracy, and it was argued that the maximum permissible error should include the effect of all these conditions, or at least of most of them. However, it is far from obvious that the effects of different influence quantities are independent from each other and therefore not obvious that one could measure the effect of each one and then sum them up by the root-mean-square law as proposed.

The concept of maximum permissible error has been central to the new Recommendation. Several comments on this matter have been received, unfortunately expressing diverging views. In the resulting draft document, IEC values have been used in some cases but additional temperature requirements have been incorporated to satisfy Nordic needs as well as those of US, Canada and Australia. The impact of these additional requirements on meters intended for mild climate or indoor application should be negligible.

A third working group meeting was held in Copenhagen at the end of March 2004 where most of the major open questions were discussed and resolved. As an outcome of this meeting, a first Committee Draft for the revised IR 46 was agreed upon and circulated to P-members, O-members, liaison international bodies and external organisations for comments.

At the fourth meeting in Borås, Sweden, a second Committee Draft was revised based on the comments received. The areas where the approach or requirements of this Recommendation draft differs from that of other standards was extensively discussed.

At the fifth meeting in Ottawa, Canada, a further extensive revision was made to refine the requirements and tests.

## Foreword

The International Organization of Legal Metrology (OIML) is a worldwide, intergovernmental organization whose primary aim is to harmonize the regulations and metrological controls applied by the national metrological services, or related organizations, of its Member States.

The two main categories of OIML publications are:

- International Recommendations (OIML R), which are model regulations that establish the metrological characteristics required of certain measuring instruments and which specify methods and equipment for checking their conformity; the OIML Member States shall implement these Recommendations to the greatest possible extent;
- International Documents (OIML D), which are informative in nature and intended to improve the work of the metrological services.

OIML Draft Recommendations and Documents are developed by technical committees or subcommittees which are formed by the Member States. Certain international and regional institutions also participate on a consultation basis.

Cooperative agreements are established between OIML and certain institutions, such as ISO and IEC, with the objective of avoiding contradictory requirements; consequently, manufacturers and users of measuring instruments, test laboratories, etc. may apply simultaneously OIML publications and those of other institutions.

International Recommendations and International Documents are published in French (F) and English (E) and are subject to periodic revision.

This publication - reference OIML R 46, edition xxxx (E) – was developed by the Working Group on the Revision of R 46 of the OIML Technical Committee TC 12/WG 1 . It was approved for final publication by the International Committee of Legal Metrology in xxxx.

OIML publications may be obtained from the Organization's headquarters:

Bureau International de Métrologie Légale  
11, rue Turgot - 75009 Paris - France  
Telephone: 33 (0)1 48 78 12 82 and 42 85 27 11  
Fax: 33 (0)1 42 82 17 27  
E-mail: [biml@oiml.org](mailto:biml@oiml.org)  
Internet: [www.oiml.org](http://www.oiml.org)

# Part 1 Metrological and technical requirements

## 1 Scope

This document sets out requirements pertinent to the metrological control of electricity meters intended for use in trade. The requirements are to be applied during type approval, verification, and re-verification. They also apply to modifications that may be made to existing approved devices.

The provisions set out here apply only to active electrical energy meters; other meter types may be addressed in future versions of this document. Meters can be direct connected for system voltages up to 690 V, or transformer operated.

## 2 Terminology

The basic terminology used in this Recommendation is defined by the OIML International Document D11 "General Requirements for Electronic Measuring Instruments" [1], and conforms to the International Vocabulary of Basic and General Terms in Metrology (VIM) [2] and the International Vocabulary of Legal Metrology (VIML) [4]. In addition, for the purposes of this Recommendation, the following definitions shall apply:

### 2.1 Meters and their constituents

#### 2.1.1 Electricity meter

Instrument intended to measure electrical energy continuously by integrating power with respect to time and to store the result.

Note: It is recognized that "continuously" may also cover meters with a sampling rate sufficiently high to fulfil the requirements of this Recommendation.

#### 2.1.2 Interval meter

Electricity meter which displays and stores the result as measured in predetermined time intervals.

#### 2.1.3 Prepayment meter

Electricity meter intended to allow electrical energy to be delivered up to a predetermined amount. Such a meter measures energy continuously and may store and display the measured energy.

Note: National authorities may specify requirements in relation to prepayment meters.

#### 2.1.4 Multi-tariff meter, multi-rate meter

Electricity meter intended to measure and display electrical energy where energy will have more than one tariff rate. The tariff rate may be determined by time, load or some other quantity.

#### 2.1.5 Direct connected meter

Meter intended for use by direct connection to the circuit(s) being measured, without the use of external device(s) such as instrument transformer(s).

#### 2.1.6 Transformer operated meter

Meter intended for use with one or more external instrument transformers.

#### 2.1.7 Electromechanical meter

Meter in which currents in fixed coils react with the currents induced in the conducting moving element, generally (a) disk(s), which causes their movement proportional to the energy to be measured. (IEC62052-11)

#### 2.1.8 Static meter

Meter in which current and voltage act on solid state (electronic) elements to produce an output proportional to the energy to be measured. (IEC62052-11)

#### 2.1.9 Measuring element

Part of the meter that transforms a current and a voltage into a signal proportional to the power and or energy.

Note: A measuring element can be based on an electromagnetic, electrical or an electronic principle.

#### 2.1.10 Current circuit

Internal connections of the meter and part of the measuring element through which flows the current of the circuit to which the meter is connected. (IEC62052-11)



**2.1.11 Voltage circuit**

Internal connections of the meter, part of the measuring element and, in the case of static meters, part of the power supply, supplied with the voltage of the circuit to which the meter is connected. (IEC62052-11)

**2.1.12 Indicating device, display**

Part of the meter that displays the measurement results either continuously or on demand.

Note: An indicating device may also be used to display other relevant information.

**2.1.13 Register**

Part of the meter that stores the measured values. It can be an electromechanical device or an electronic device. The register may be integral to the indicating device.

**2.1.14 Primary rated register**

For transformer operated meters. A register where the scale factor(s) due to the used instrument transformer(s) is considered such that the measured energy on the primary side of the instrument transformer(s) is indicated.

**2.1.15 Register multiplier**

Constant with which the register reading shall be multiplied to obtain the value of the metered energy.

**2.1.16 Meter constant**

Value expressing the relation between the energy registered by the meter and the corresponding value of the test output.

**2.1.17 Test output**

Device which can be used for testing of the meter, providing pulses or the means to provide pulses corresponding to the energy measured by the meter.

**2.1.18 Adjustment device**

Device or function incorporated in the meter that allows the error curve to be shifted with a view to bringing errors (of indication) within the maximum permissible errors.

**2.1.19 Auxiliary device**

Device within the meter that is not part of the basic metrology function.

**2.2 Metrological characteristics****2.2.1 Current ( $I$ )**

R.m.s. value of the electrical current flowing through the meter.

Note: The terms "current" and "voltage" in this Recommendation indicate r.m.s. (root mean square) values unless otherwise specified.

**2.2.2 Starting current ( $I_{st}$ )**

Lowest value of current specified by the manufacturer at which the meter should register electrical energy at unity power factor and, for poly-phase meters, with balanced load.

**2.2.3 Minimum current ( $I_{min}$ )**

Lowest value of current at which the meter is specified by the manufacturer to meet the accuracy requirements of this Recommendation.

**2.2.4 Transitional current ( $I_{tr}$ )**

Value of current at and above which the meter is specified by the manufacturer to lie within the smallest maximum permissible error corresponding to the accuracy class of the meter.

**2.2.5 Maximum current ( $I_{max}$ )**

Highest value of current at which the meter is specified by the manufacturer to meet the accuracy requirements of this Recommendation.

**2.2.6 Voltage ( $U$ )**

R.m.s. value of the electrical voltage supplied to the meter.

**2.2.7 Nominal voltage ( $U_{\text{nom}}$ )**

Voltage specified by the manufacturer for normal operation of the meter. Meters designed for operation across a range of voltages may have several nominal voltage values.

**2.2.8 Frequency ( $f$ )**

Frequency of the voltage (and current) supplied to the meter.

**2.2.9 Nominal frequency ( $f_{\text{nom}}$ )**

Frequency of the voltage (and current) specified by the manufacturer for normal operation of the meter.

**2.2.10 Harmonic**

Part of a signal that has a frequency that is an integer multiple of the fundamental frequency of the signal. The fundamental frequency is generally the nominal frequency ( $f_{\text{nom}}$ )

**2.2.11 Sub-harmonic**

Frequency that is an integer fraction of the fundamental frequency of the signal.

**2.2.12 Harmonic number**

Integer number used to identify a harmonic. It is the ratio of the frequency of a harmonic to the fundamental frequency of the signal.

**2.2.13 Distortion factor ( $d$ )**

Ratio of the r.m.s. value of the harmonic content (obtained e.g. by subtracting from a non-sinusoidal alternating quantity its fundamental term) to the r.m.s. value of the fundamental term. The distortion factor is usually expressed in percentage. It is equivalent to THD, total harmonic distortion.

**2.2.14 Power factor (PF)**

Ratio of the active power to the apparent power. At sinusoidal and either one-phase or symmetrical three-phase conditions, the power factor =  $\cos \Phi$  = the cosine of the phase difference  $\Phi$  between voltage  $U$  and current  $I$ .

**2.2.15 Active power**

Rate at which energy is transported. In an electrical system it is measured as the time mean of the instantaneous power, which is calculated at each instant as the product of voltage and current.

$$p(t) = u(t) \cdot i(t)$$

where:

$u$  is the instantaneous voltage

$i$  is the instantaneous current

$p$  is the instantaneous power

At sinusoidal conditions active power is the product of the r.m.s. value of current and voltage and the cosine of the phase angle between them, calculated for each phase. It is usually expressed in kW.

$$\text{Active power } P = U_{r.m.s.} \cdot I_{r.m.s.} \cdot \cos \Phi .$$

**2.2.16 Active energy**

Active power integrated over time. Usually expressed in kW·h or MW·h

$$E(T) = \int_0^T p(t) \cdot dt = \int_0^T u(t) \cdot i(t) \cdot dt$$

where:

$E$  is the active energy. Other symbols are as defined in 2.2.15

**2.2.17 Relative error (of indication)**

Measured quantity value minus true quantity value, divided by the true quantity value. The relative error is usually expressed as a percentage of the true quantity value.

Note: Since this Recommendation deals only with relative error, the short form "error" is used for relative error.

**2.2.18 Maximum permissible error (m.p.e.)**

See definition in Annex A.

Note: In this Recommendation, the maximum permissible error is a combination of the base maximum permissible error and the maximum permissible error shift as described in Annex C.

**2.2.19 Base maximum permissible error**

Extreme values of the error (of indication) of a meter, permitted by this Recommendation, when the current and power factor are varied within the intervals given by the rated operating conditions, and when the meter is otherwise operated at reference conditions.

Note: In this Recommendation, the maximum permissible error is a combination of the base maximum permissible error and the maximum permissible error shift as described in Annex C.

**2.2.20 Maximum permissible error shift**

Extreme values of the change in error (of indication) of a meter, permitted by this Recommendation, when a single influence factor is taken from its value at reference conditions and varied within the rated operating conditions. For each influence factor there is one corresponding maximum permissible error shift.

Note: In this Recommendation, the maximum permissible error is a combination of the base maximum permissible error and the maximum permissible error shift as described in Annex C.

**2.2.21 Intrinsic error**

See definition in Annex A. [VIM:1993, 5.24; OIML D11:2004, 3.7]

**2.2.22 Initial intrinsic error**

Intrinsic error of a measuring instrument as determined prior to performance tests and durability evaluations. [OIML D11:2004, 3.8]

**2.2.23 Influence quantity**

See definition in Annex A. [VIM:1993, 2.7]

**2.2.24 Influence factor**

Influence quantity having a value within the rated operating conditions specified in this Recommendation. [OIML D11:2004, 3.13.1, modified]

**2.2.25 Disturbance**

Influence quantity having a value within limits specified in this Recommendation, but outside the specified rated operating conditions of the meter. (OIML D11, modified)

Note: An influence quantity is a disturbance if the rated operating conditions for that influence quantity are not specified.

**2.2.26 Rated operating condition**

See definition in Annex A. [VIM:2007, 4.9]

**2.2.27 Reference condition**

See definition in Annex A. [VIM:2007, 4.11]

**2.2.28 Accuracy class**

See definition in Annex A. [VIM:2007, 4.25]

Note: In this recommendation, the stated metrological requirements for accuracy class include permissible responses to disturbances.

**2.2.29 Durability**

Ability of a measuring instrument to maintain its performance characteristics over a period of use. (OIML D11)

**2.2.30 Fault**

Difference between the error of indication and the intrinsic error of a measuring instrument. (OIML D11)

Note 1: Principally, a fault is the result of an undesired change of data contained in or flowing through a measuring instrument.

Note 2: From the definition it follows that in this Document, a "fault" is a numerical value which is expressed either in a unit of measurement or as a relative value, for instance as a percentage.

Note 3: In this Document, the above definition does not apply to the term ‘earth fault’, in which the word ‘fault’ has its usual dictionary meaning.

### 2.2.31 Significant fault

Fault greater than the value specified in this Recommendation (OIML D11).

The following are also considered to be significant faults:

- A change larger than the critical change value has occurred in the measurement registers due to disturbances.
- The functionality of the meter has become impaired.

### 2.2.32 Checking facility

Facility that is incorporated in the meter and which enables faults that would otherwise be significant faults to be detected and acted upon in such a way that incorrect registration is prohibited or recorded separately. (OIML D11, modified)

Faults that are detected and acted upon by means of a checking facility shall not be considered as significant faults.

Note: The action should be either to stop measuring and record the time and duration of the stop, or record the time and duration of the fault and the amount of energy measured during the fault.

### 2.2.33 Primary Register

Register that is subject to the requirements of this recommendation.

## 3 Metrological Requirements



















### 3.1 Units of measurement

The units of measurement for active electrical energy shall be one of the following units: W·h, kW·h, MW·h, GW·h.

### 3.2 Rated operating conditions

**Table 1. Rated operating conditions**

Condition or influence quantity	Values, Ranges																																						
Frequency	$f_{nom} \pm 2\%$ where $f_{nom}$ is to be specified by the manufacturer. If the manufacturer specifies more than one nominal frequency, the rated operating conditions shall be the combination of all $f_{nom} \pm 2\%$ intervals																																						
Voltage	$U_{nom} \pm 10\%$ where $U_{nom}$ is to be specified by the manufacturer. Meters designed to operate across a range of voltages shall have applicable $U_{nom}$ 's specified by the manufacturer. If the manufacturer specifies more than one nominal voltage the rated operating conditions shall be the combination of all $U_{nom} \pm 10\%$ intervals.																																						
Current	<p><math>I_{st}</math> to <math>I_{max}</math> <math>I_{max}</math> and <math>I_{tr}</math> are to be specified by the manufacturer. The ratio <math>I_{max}/I_{tr}</math> must be equal to or higher than 50 for direct connected meters and equal to or higher than 24 for transformer operated meters.</p> <table border="1"> <thead> <tr> <th rowspan="2"><math>I_{min}</math></th> <th colspan="4">Accuracy Class</th> </tr> <tr> <th>A</th> <th>B</th> <th>C</th> <th>D</th> </tr> </thead> <tbody> <tr> <td>Direct Connected</td> <td><math>0.5 I_{tr}</math></td> <td><math>0.4 I_{tr}</math></td> <td><math>0.2 I_{tr}</math></td> <td><math>0.2 I_{tr}</math></td> </tr> <tr> <td>Transformer Operated</td> <td><math>0.4 I_{tr}</math></td> <td><math>0.2 I_{tr}^{(1)}</math></td> <td><math>0.2 I_{tr}</math></td> <td><math>0.2 I_{tr}</math></td> </tr> </tbody> </table> <p>(1) <math>0.4 I_{tr}</math> for class B transformer operated electromechanical meters.</p> <table border="1"> <thead> <tr> <th rowspan="2"><math>I_{st}</math></th> <th colspan="4">Accuracy Class</th> </tr> <tr> <th>A</th> <th>B</th> <th>C</th> <th>D</th> </tr> </thead> <tbody> <tr> <td>Direct Connected</td> <td><math>0.05 I_{tr}</math></td> <td><math>0.04 I_{tr}</math></td> <td><math>0.04 I_{tr}</math></td> <td><math>0.04 I_{tr}</math></td> </tr> <tr> <td>Transformer Operated</td> <td><math>0.05 I_{tr}</math></td> <td><math>0.04 I_{tr}</math></td> <td><math>0.02 I_{tr}</math></td> <td><math>0.02 I_{tr}</math></td> </tr> </tbody> </table>	$I_{min}$	Accuracy Class				A	B	C	D	Direct Connected	$0.5 I_{tr}$	$0.4 I_{tr}$	$0.2 I_{tr}$	$0.2 I_{tr}$	Transformer Operated	$0.4 I_{tr}$	$0.2 I_{tr}^{(1)}$	$0.2 I_{tr}$	$0.2 I_{tr}$	$I_{st}$	Accuracy Class				A	B	C	D	Direct Connected	$0.05 I_{tr}$	$0.04 I_{tr}$	$0.04 I_{tr}$	$0.04 I_{tr}$	Transformer Operated	$0.05 I_{tr}$	$0.04 I_{tr}$	$0.02 I_{tr}$	$0.02 I_{tr}$
$I_{min}$	Accuracy Class																																						
	A	B	C	D																																			
Direct Connected	$0.5 I_{tr}$	$0.4 I_{tr}$	$0.2 I_{tr}$	$0.2 I_{tr}$																																			
Transformer Operated	$0.4 I_{tr}$	$0.2 I_{tr}^{(1)}$	$0.2 I_{tr}$	$0.2 I_{tr}$																																			
$I_{st}$	Accuracy Class																																						
	A	B	C	D																																			
Direct Connected	$0.05 I_{tr}$	$0.04 I_{tr}$	$0.04 I_{tr}$	$0.04 I_{tr}$																																			
Transformer Operated	$0.05 I_{tr}$	$0.04 I_{tr}$	$0.02 I_{tr}$	$0.02 I_{tr}$																																			

Power factor	From 0.5 inductive to 1 to 0.8 capacitive, except for classes C and D where the operating range is from 0.5 inductive to 1 to 0.5 capacitive. For bi-directional meters the power factor range limits are valid in both directions.														
Temperature	From lower temperature limit to upper temperature limit as specified by manufacturer. The manufacturer shall specify the lower temperature limit from the values: -55°C, -40°C, -25°C, -10°C. The manufacturer shall specify the upper temperature limit from the values: +40°C, +55°C, +70°C.														
Humidity and water	With respect to humidity, the manufacturer shall specify the environment class for which the instrument is intended: H1: enclosed locations where the instruments are not subjected to condensed water, precipitation, or ice formations; H2: enclosed locations where the instruments may be subjected to condensed water, to water from sources other than rain and to ice formations; H3: open locations with average climatic conditions.														
Connection modes	<p>The manufacturer shall specify whether the meter is intended for direct connection, connection through current transformers or through current and voltage transformers.</p> <p>The manufacturer shall specify the connection mode(s), the number of measurement elements of the meter and the number of phases of the electric system for which the meter is intended.</p> <p>A meter in accordance with this recommendation can be one or more of the following:</p> <table border="1"> <thead> <tr> <th>Symbol <sup>(1)</sup></th> <th>Description</th> </tr> </thead> <tbody> <tr> <td></td> <td>single-phase two-wire, 1 element</td> </tr> <tr> <td></td> <td>single phase three-wire, 1 element (applicable only for balanced and symmetrical voltages)</td> </tr> <tr> <td></td> <td>single phase three-wire, 2 element</td> </tr> <tr> <td></td> <td>three-phase four-wire 3-element</td> </tr> <tr> <td></td> <td>three-phase three-wire 2-element (applicable only in cases where leakage currents can be ruled out)</td> </tr> <tr> <td></td> <td>two-phase three-wire 2 element (intended for operation on two phases of a three-phase service. Can also be a three-phase meter operated as two-phase three-wire)</td> </tr> </tbody> </table> <p>(1) Symbols have been taken from IEC 62053-52 [38].</p> <p>The manufacturer may specify alternative connection modes for poly-phase meters. These alternative connection mode(s) shall also be part(s) of the operating conditions.</p>	Symbol <sup>(1)</sup>	Description		single-phase two-wire, 1 element		single phase three-wire, 1 element (applicable only for balanced and symmetrical voltages)		single phase three-wire, 2 element		three-phase four-wire 3-element		three-phase three-wire 2-element (applicable only in cases where leakage currents can be ruled out)		two-phase three-wire 2 element (intended for operation on two phases of a three-phase service. Can also be a three-phase meter operated as two-phase three-wire)
Symbol <sup>(1)</sup>	Description														
	single-phase two-wire, 1 element														
	single phase three-wire, 1 element (applicable only for balanced and symmetrical voltages)														
	single phase three-wire, 2 element														
	three-phase four-wire 3-element														
	three-phase three-wire 2-element (applicable only in cases where leakage currents can be ruled out)														
	two-phase three-wire 2 element (intended for operation on two phases of a three-phase service. Can also be a three-phase meter operated as two-phase three-wire)														
Tilt	Mounting position as specified by the manufacturer $\pm 3$ degrees. If no mounting position is given, any mounting position is allowed.														
Harmonics	The voltage and current shall be allowed to deviate from the sinusoidal form, as given by the requirements in clause 3.3.3, Table 4, "Harmonics in voltage and current circuits".														
Load balance	The load balance shall be allowed to vary from fully balanced conditions to current in only one current circuit for poly-phase meters and for single-phase 3-wire meters.														
Note: National authorities or regional legislation may specify certain values for various rated operating conditions. See Annex D.															

### 3.3 Accuracy requirements

#### 3.3.1 General

The manufacturer shall specify the accuracy class of the meter to be one of A, B, C or D.

[R46CD5A \(17 September 2010\)](#)

Note: Class B is the lowest accuracy class recommended for large consumers, i.e. where consumption exceeds 5000 kW·h/year, or another value chosen by the appropriate authority.

The meter shall be designed and manufactured such that its error does not exceed the maximum permissible error for the specified class under rated operating conditions.

The meter shall be designed and manufactured such that, when exposed to disturbances, significant faults do not occur.

A fault is not considered a significant fault if it is detected and acted upon by means of a checking facility. The meter shall clearly indicate if such an event has occurred (cf. clauses 2.2.31 and 2.2.32).

Note: The indication could take the form of a light flashing in the event of a fault.

### 3.3.2 Direction of energy flow

Where a manufacturer has specified that a meter shall be capable of bidirectional energy flow, the meter shall correctly handle both positive and negative mean energy flow and the meter shall fulfil the requirement of this Recommendation for energy flow in both directions. The polarity of energy flow shall be defined by the manufacturer's connection instructions for the meter. Mean energy flow refers to the active power integrated over at least one cycle of the nominal frequency. For poly-phase meters the mean flow shall be over the sum of all phases.

A meter shall fall into at least one of the following categories:

- Single-register, bi-directional; where the meter is specified as capable of measuring both positive and negative mean energy flow, and where the net result will be placed in a single register.
- Two-register, bi-directional; where the meter is specified as capable of measuring both positive and negative mean energy flow, as defined by the connection of the meter, and where the positive result and negative result are placed in different registers.
- Single-register, positive direction only; where the meter is specified as capable of measuring and registering only positive mean energy flow. It may inherently, by its design, register only positive mean energy flow or it may be equipped with a reverse running detent.
- Single-register, uni-directional; where the meter is specified as capable of measuring and registering the absolute value of the mean energy flow. Normally such a meter will register all energy as consumed energy independent of the true direction of the energy flow or of how the meter is connected.

Note: The terms "single-register" and "two-register" in the list above refer to the basic energy register(s) only. A meter may have other registers, e.g. for storage of tariff information.

### 3.3.3 Maximum permissible errors

The relative error (expressed in percent) shall be within the base maximum permissible error stated in Table 2 when the current and power factor are varied within the limits given by Table 2, and when the meter is otherwise operated at reference conditions. Individual national authorities may specify the base maximum permissible errors for subsequent verification and in-service inspections.

**Table 2. Base maximum permissible errors and no load requirements**

Quantity		Base maximum permissible errors (%) for meters of class			
		A	B	C	D
Current $I$ where $I_{tr} \leq I \leq I_{max}$ , and power factor variation from 0.8 capacitive to 1 to 0.5 inductive		±2.0	±1.0	±0.5 <sup>(1)</sup>	±0.2 <sup>(1)</sup>
Current $I$ where $I_{min} \leq I < I_{tr}$ , at unity power factor		±2.5	±1.5	±1.0	±0.4
Current $I_{st} \leq I < I_{min}$ , at unity power factor <sup>(2)</sup>	Direct connected meter	±2.5* $I_{tr}/(2*I)$	±1.5* $I_{tr}/(2.5*I)$	±1.0* $I_{tr}/(5*I)$	±0.4* $I_{tr}/(5*I)$
	Transformer operated meter	±2.5* $I_{tr}/(2.5*I)$	±1.5* $I_{tr}/(2.5*I)$	±1.0* $I_{tr}/(5*I)$	±0.4* $I_{tr}/(5*I)$
No load <sup>(2)</sup>		No significant metered energy as given by the corresponding test.			
(1) For this class the power factor requirement is from 0.5 inductive to 1 to 0.5 capacitive.					
(2) The meter is always allowed to stop for currents below $I_{st}$ .					

The meter shall be able to carry  $I_{max}$  continuously without an error larger than the base maximum permissible error for a meter of its class (see section 6.2.2 for details of test procedure). Further, the error shift due to continuous current at  $I_{max}$  shall not be larger than 50% of the base maximum permissible error for the relevant class.

### 3.3.4 Allowed effects of influences

The temperature coefficient of the meter shall fulfil the requirements of [Table 3](#), when the meter is otherwise operated at reference conditions.

Deleted: Table 3

**Table 3. Limits for temperature coefficient of error**

Influence quantity	Power factor	Limits for temperature coefficient (%/K) for meters of class			
		A	B	C	D
Temperature Coefficient (%/K), over any interval, within the temperature range, which is not less than 15K and not greater than 23K, for current $I_{tr} \leq I \leq I_{max}$	1	±0.1	±0.05	±0.03	±0.01
	0.5 inductive	±0.15	±0.07	±0.05	±0.02

When the load current and power factor are held constant at a point within the rated operating range with the meter otherwise operated at reference conditions, and when any single influence quantity is varied from its value at reference conditions to its extreme values defined in Table 4, the variation of error shall be such that the additional percentage error is within the corresponding limit of error shift stated in Table 4. An error shift larger than that prescribed in Table 4 constitutes a significant fault. The meter shall continue to function after the completion of each of these tests.

**Table 4. Limit of error shift due to influence quantities.**

Influence quantity	Value	Test Clause	Value of Current	Power factor	Limit of error shift (%) for meters of class			
					A	B	C	D
Temperature dependence	Over entire specified temperature range	6.3.2	$I_{tr} \leq I \leq I_{max}$	1	±3.3	±1.7	±0.7	±0.3
				0.5 inductive				
Load balance <sup>(1)</sup>	Current in only one current circuit	6.3.3	$I_{tr} \leq I \leq I_{max}$	1	±1.5 <sup>(2)</sup>	±0.7	±0.2	±0.1
				0.5 inductive				
Voltage variation <sup>(3)</sup>	$U_{nom} \pm 10\%$	6.3.4	$I_{tr} \leq I \leq I_{max}$	1	±1.0 <sup>(9)</sup>	±0.7	±0.2	±0.1
				0.5 inductive				
Frequency variation	$f_{nom} \pm 2\%$	6.3.5	$I_{tr} \leq I \leq I_{max}$	1	±0.8	±0.5	±0.2	±0.1
				0.5 inductive				
Harmonics in voltage and current circuits	$d$ is 0 – 40% $I$ , 0 – 5% $U$ <sup>(4)</sup>	6.3.6	$I_{tr} \leq I \leq I_{max}$	1	±1.0 <sup>(5)</sup>	±0.6	±0.3	±0.2
Tilt	≤ 3 degrees	6.3.7	$I_{tr} \leq I \leq I_{max}$	1	±1.5	±0.5	±0.4	n.a
Damp heat	Refer to test corresponding to humidity class.	6.4.16.3, 6.4.16.4	$I_{tr} \leq I \leq I_{max}$	1	±0.2	±0.1	±0.05	±0.02
Severe voltage variations	$0.8 U_{nom} \leq U < 0.9 U_{nom}$ ; $1.1 U_{nom} < U \leq 1.15 U_{nom}$	6.3.8	As defined in test	1	±1.5	±1	±0.6	±0.3
	$U < 0.8 U_{nom}$							
One or two phases interrupted <sup>(6)</sup>		6.3.9	As defined in test	1	±4	±2	±1	±0.5
Sub-harmonics in the AC current circuit	Two periods on, two periods off	6.3.10	As defined in test	1	±3	±1.5	±0.75	±0.5

Deleted: R46CD5 (30 July 2010)

Harmonics in the AC current circuit	Phase-fired at 90 degrees	6.3.11	As defined in test	1	±1	±0.8	±0.5	±0.4
Reversed phase sequence	Any two phases interchanged	6.3.12	As defined in test	1	±1.5	±1.5	±0.1	±0.05
Continuous (DC) magnetic induction of external origin	200 mT <sup>(†)</sup> at 30 mm from core surface	6.3.13	As defined in test	1	±3	±1.5	±0.75	±0.5
Magnetic field (AC, power frequency) of external origin.	400 A/m	6.3.14	As defined in test	1	±2.5	±1.3	±0.5	±0.25
Radiated, RF, electromagnetic fields <sup>(7)</sup>	$f = 80$ to $6000$ MHz; $\leq 10$ V/m; Amplitude modulated	6.3.15.1	As defined in test	1	±3	±2	±1	±1
Conducted disturbances, induced by radio frequency fields	$f = 0.15$ to $80$ MHz; $U \leq 10$ V; amplitude modulated	6.3.15.2	As defined in test	1	±3	±2	±1	±1
DC in the AC current circuit <sup>(8)</sup>	Sinusoidal current, twice amplitude, half-wave rectified; $I \leq I_{\max}/\sqrt{2}$	6.3.16	As defined in test	1	±6	±3	±1.5	±1
High-order harmonics	Superimposed: $0.02 U_{\text{nom}}$ ; $0.1 I_{\text{tr}}$ ; $15 f_{\text{nom}}$ to $50 f_{\text{nom}}$	6.3.17	As defined in test	1	±1	±1	±0.5	±0.5

(1) Only for poly-phase and single phase 3-wire meters

(2) The error shift may exceed the value specified in the table provided the absolute value of the error is less than 2.5 %.

(3) For poly-phase meters the requirement is for symmetrical voltage variations.

(4) As long as the r.m.s. current is not higher than  $I_{\max}$  and the peak value of the current is not higher than  $1.41 \cdot I_{\max}$ . Furthermore, the amplitude of individual harmonic components shall not exceed  $(I_1 / h)$  for current and  $(0.12 \cdot U_1 / h)$  for voltage, where  $h$  is the harmonic order.

(5) In the case of electromechanical meters, the error shift may exceed the value specified in the table provided the absolute value of the error is less than 3.0%.

(6) Only for poly-phase meters. Two phases interrupted is only for those connection modes where a missing phase means that there can be no energy delivered. This requirement applies only to fault conditions of the network, not for an alternative connection mode. A poly-phase meter which is powered from only one of its phases shall not have the voltage of that phase interrupted for the purposes of this test.

(7) Direct or indirect, conducted disturbances induced by radio-frequency fields.

(8) Only for direct connected meters.

(9) For class A, electromechanical meters, the requirement is not applicable below  $10 I_{\text{tr}}$ .

(†) (Editor's note) modern magnets producing induction in excess of 100 mT at 25 mm have been used in known fraud attempts. This test level is designed to avoid the possibility to use magnets easily available for fraud purposes. This note will be removed later.

### 3.3.5 Allowed effects of disturbances

#### 3.3.5.1 General

The meter shall withstand disturbances which may be encountered under conditions of normal use; as stated in clause 3.3.1, no significant fault shall occur for any of the disturbances listed in Table 5.

#### 3.3.5.2 Disturbances

If a meter is operated under the conditions outlined in Table 5 and no current is applied, a change in the registers or pulses of the test output shall not be considered as a significant fault if the change in the registers or equivalent energy of the test output is less than:

$$\text{Critical change value} = m \cdot U_{\text{nom}} \cdot I_{\max} \cdot 10^{-6} \text{ kW}\cdot\text{h},$$

where  $m$  is the number of measuring elements.

[R46CD5A \(17 September 2010\)](#)



Table 5. Disturbances

Disturbance quantity	Test Clause	Test Settings <sup>(4)</sup>	Allowed effects	Limit of error shift (%) for meters of class			
				A	B	C	D
Magnetic field (AC, power frequency) of external origin.	6.4.2	1000 A/m, 3 s	No significant fault as given by the corresponding test.	-	-	-	-
Electrostatic discharges	6.4.3	6 kV contact discharge, 8 kV air discharge	No significant fault as given by the corresponding test.	-	-	-	-
Fast transients	6.4.4	Voltage and current circuits: 4kV; auxiliary circuits: 2 kV.	No significant fault as given by the corresponding test. The function of the meter shall not be perturbed.	6.0	4.0	2.0	1.0
Voltage dips	6.4.5	Test a: 30%, 0.5 cycles Test b: 60%, 1 cycle Test c: 60%, 25/30 cycles <sup>(3)</sup>	No significant fault as given by the corresponding test.	-	-	-	-
Voltage interruptions	6.4.5	0%, 250/300 cycles <sup>(3)</sup>	No significant fault as given by the corresponding test.	-	-	-	-
Radiated, RF, electromagnetic fields	6.4.6	f = 80 to 6000 MHz; 30 V/m; amplitude modulated; without current	No significant fault as given by the corresponding test.	-	-	-	-
Surges on AC mains power lines	6.4.7	Voltage circuits: 2kV line to line, 4kV line to earth. Auxiliary circuits: 1kV line to line, 2kV line to earth.	No significant fault as given by the corresponding test.	-	-	-	-
Damped oscillatory waves immunity test <sup>(1)</sup>	6.4.8	Voltage circuits: Common mode 2.5 kV, differential mode 1.0 kV.	No significant fault as given by the corresponding test. The function of the meter shall not be perturbed.	3.0	2.0	2.0	1.0
Short-time overcurrent	6.4.9	Direct connected meters: $30 \cdot I_{max}$ ; Transformer-operated meters: $20 \cdot I_{max}$ .	No significant fault as given by the corresponding test. No damage shall occur.	Transformer-operated			
				1.0	0.5	0.05	0.05
				Direct connected			
				1.5	1.5	0.05	0.05
Impulse voltage	6.4.10	Refer to test clause.	No significant fault as given by the corresponding test. No damage to the meter. No other effects as specified in the test section.	-	-	-	-
Earth fault <sup>(2)</sup>	6.4.11	Earth fault in one phase	No significant fault as given by the corresponding test. No damage and shall operate correctly.	1.0	0.7	0.3	0.1
Operation of auxiliary devices	6.4.12	Auxiliary devices operated with $I = I_{tr}$ and $I_{max}$	No significant fault as given by the corresponding test.	1/10 of base m.p.e			
Vibration	6.4.13.1	Vibration in three mutually perpendicular axes.	No significant fault as given by the corresponding test. Function of the meter shall not be impaired.	1/10 base m.p.e.		½ base m.p.e	
Shock	6.4.13.2	Refer to test clause.	No significant fault as given by the corresponding test.	1/10 base m.p.e.		½ base m.p.e	

Protection against solar radiation	6.4.14	Refer to test clause.	No alteration in appearance or impairment in functionality, metrological properties and sealing.	-	-	-	-
Protection against ingress of dust	6.4.15	Refer to test clause.	No interference with correct operation or impairment of safety, including tracking along creepage distances.	-	-	-	-
Extreme temperatures, dry heat and cold.	6.4.16.1, 6.4.16.2	Refer to test clause.	No significant fault as given by the corresponding test.	1/10 base m.p.e.		½ base m.p.e	
Humidity and water	6.4.16.3, 6.4.16.4, 6.4.16.5	Refer to test clause.	No significant fault as given by the corresponding test. No evidence of any mechanical damage or corrosion.	-	-	-	-
<u>Durability</u>	6.4.17	<u>Dry Heat (upper specified temperature for meter), 1.1</u> <u><math>U_{nom}</math>, <math>I_{max}</math>, 1000 hours</u>	<u>No significant fault as given by the corresponding test.</u>			<u>½ base m.p.e.</u>	
<p>(1) Only for transformer operated meters.</p> <p>(2) Only for three-phase four wire transformer-operated meters intended for use in networks equipped with earth fault neutralizers</p> <p>(3) These values are for 50 Hz / 60 Hz respectively</p> <p>(4) This column only lists notable test settings. All test settings are defined in the corresponding test clause.</p>							

Deleted: -¶

-¶

-¶

-

If no significant fault occurs during the appropriate tests described in Part 2 of this Recommendation, the meter is presumed to comply with the requirements of this sub-clause.

### 3.4 Timing requirements for interval and multi-tariff meters

Interval meters shall be able to measure and store interval data for a minimum of 35 days of 30-minute interval data. Individual national authorities may specify longer minimum storage periods.

The internal clocks of interval and multi-tariff meters shall meet the requirements of IEC 62054-21.

### 3.5 Meter Markings

Individual national authorities shall determine what information must be marked on every meter. It is recommended that the following be considered:

- Manufacturer
- $U_{nom}$
- $I_{max}$
- $I_{tr}$
- Approval mark(s)
- Serial number
- Number of phases
- Number of wires
- Register multiplier (if other than unity)
- Meter constant(s)
- Year of manufacture
- Accuracy class
- Directionality of energy flow if the meter is bidirectional or unidirectional. No marking is required if the meter is capable only of positive direction energy flow.
- Meter type
- Temperature range
- Humidity and water protection information

[R46CD5A \(17 September 2010\)](#)

Page 18 of 62

Deleted: R46CD5 (30 July 2010)

- Impulse voltage protection information
- $f_{nom}$
- The connection mode(s) for which the meter is specified
- Connection terminals uniquely identified to distinguish between terminals.

The markings shall be indelible, distinct and legible from outside the meter. The markings of meters intended for outdoor locations shall withstand solar radiation. Multiple values of  $U_{nom}$  and  $f_{nom}$  may be marked if so specified by the manufacturer.

If the serial number is affixed to dismountable parts, the serial number shall also be provided in a position where it is not readily disassociated from parts determining the metrological characteristics.

Symbols or their equivalent may be used where appropriate. See e.g. IEC 62053-52, Electricity metering equipment (AC) - Particular requirements - Part 52: Symbols, or other designations accepted by local jurisdictions.

### 3.6 Protection of metrological properties

#### 3.6.1 General

3.6.1.1 Electricity meters shall be provided with the means to protect their metrological properties.

3.6.1.2 All means to protect the metrological properties of an electricity meter intended for outdoor locations shall withstand solar radiation.

#### 3.6.2 Software identification

Legally relevant software of an electricity meter shall be clearly identified with the software version or another token. The identification may consist of more than one part but at least one part shall be dedicated to the legal purpose.

The identification shall be inextricably linked to the software itself and shall be presented on command or displayed during operation.

As an exception, an imprint of the software identification on the electricity meter shall be an acceptable solution if it satisfies the three following conditions:

- 1) The user interface does not have any control capability to activate the indication of the software identification on the display, or the display does not technically allow the identification of the software to be shown (analog indicating device or electromechanical counter).
- 2) The electricity meter does not have an interface to communicate the software identification.
- 3) After production of the electricity meter a change of the software is not possible, or only possible if the hardware or a hardware component is also changed.

The manufacturer of the hardware or the concerned hardware component is responsible for ensuring that the software identification is correctly marked on the concerned meter.

The software identification and the means of identification shall be stated in the type approval certificate.

#### 3.6.3 Software protection

##### 3.6.3.1 Prevention of misuse

An electricity meter shall be constructed in such a way that possibilities for unintentional, accidental, or intentional misuse are minimal.

##### 3.6.3.2 Fraud protection

3.6.3.2.1 The legally relevant software shall be secured against unauthorized modification, loading, or changes by swapping the memory device. In addition to mechanical sealing, technical means may be necessary to secure electricity meters having an option to load software/parameters.

3.6.3.2.2 Only clearly documented functions (see 4.1) are allowed to be activated by the user interface, which shall be realized in such a way that it does not facilitate fraudulent use.

3.6.3.2.3 Software protection comprises appropriate sealing by mechanical, electronic and/or cryptographic means, making an unauthorized intervention impossible or evident.

Examples:

- 1) The software of a measuring instrument is constructed such that there is no way to modify the parameters and legally relevant configuration but via a switch protected menu. This switch is mechanically sealed in the inactive position, making modification of the parameters and of the legally relevant configuration impossible. To modify the parameters and configuration, the switch has to be switched, inevitably breaking the seal by doing so.
- 2) The software of a measuring instrument is constructed such that there is no way to access the parameters and legally relevant configuration but by authorized persons. If a person wants to enter the parameter menu item he has to insert his smart card containing a PIN as part of a cryptographic certificate. The software of the instrument is able to verify the authenticity of the PIN by the certificate and allows the parameter menu item to be entered. The access is recorded in an audit trail including the identity of the person (or at least of the smart card used).

### 3.6.4 Parameter protection

3.6.4.1 Parameters that fix the legally relevant characteristics of the electricity meter shall be secured against unauthorized modification. If necessary for the purpose of verification, the current parameter settings shall be able to be displayed.

Device-specific parameters may be adjustable or selectable only in a special operational mode of the electricity meter. They may be classified as those that should be secured (unalterable) and those that may be accessed (settable parameters) by an authorized person, e.g. the instrument owner, repairer.

Type-specific parameters have identical values for all specimens of a type. They are fixed at type approval of the instrument.

Note 1: A simple password is not a technically acceptable solution for protecting parameters.

Note 2: Authorized persons may be allowed to access a limited set of device-specific parameters. Such a set of device specific parameters and its access limitations/rules should be clearly documented.

3.6.4.2 Zeroing the register that stores the total energy metered shall be considered as a modification of a device specific parameter. Therefore all relevant requirements applicable to device specific parameter are applicable to the zeroing operation.

3.6.4.3 When modifying a device-specific parameter, the meter shall stop registering energy.

3.6.4.4 National regulations may prescribe that certain device-specific parameters to be available to the user. In such a case, the measuring instrument shall be fitted with a facility to automatically and non-erasably record any adjustment of the device-specific parameter, e.g. an audit trail. The instrument shall be capable of presenting the recorded data.

The traceability means and records are part of the legally relevant software and should be protected as such. The software employed for displaying the audit trail belongs to the fixed legally relevant software.

Note: An event counter is not a technically acceptable solution.

### 3.6.5 Separation of electronic devices and sub-assemblies

Metrologically critical parts of an electricity meter – whether software or hardware parts – shall not be inadmissibly influenced by other parts of the meter.

3.6.5.1 Sub-assemblies or electronic devices of an electricity meter that perform legally relevant functions shall be identified, clearly defined, and documented. They form the legally relevant part of the measuring system. If the sub-assemblies that perform legally relevant functions are not identified, all sub-assemblies shall be considered to perform legally relevant functions.

Example:

- 1) An electricity meter is equipped with an optical interface for connecting an electronic device to read out measurement values. The meter stores all the relevant quantities and keeps the values available for being read out for a sufficient time span. In this system only the electricity meter is the legally relevant device. Other legally non-relevant devices may exist and may be connected to the interface of the instrument provided requirement 3.6.5.2 is fulfilled. Securing of the data transmission itself (see 3.6.7) is not required.

3.6.5.2 During type testing, it shall be demonstrated that the relevant functions and data of sub-assemblies and electronic devices cannot be inadmissibly influenced by commands received via the interface.

This implies that there is an unambiguous assignment of each command to all initiated functions or data changes in the sub-assembly or electronic device.

Note: If “legally relevant” sub-assemblies or electronic devices interact with other “legally relevant” sub-assemblies or electronic devices, refer to 3.6.7.

## Examples:

- 1) The software of the electricity meter (see example of 3.6.5.1 above) is able to receive commands for selecting the quantities required. It combines the measurement value with additional information – e.g. time stamp, unit – and sends this data set back to the requesting device. The software only accepts commands for the selection of valid allowed quantities and discards any other command, sending back only an error message. There may be securing means for the contents of the data set but they are not required, as the transmitted data set is not subject to legal control.
- 2) Inside the housing that can be sealed there is a switch that defines the operating mode of the electricity meter: one switch setting indicates the verified mode and the other the non-verified mode (securing means other than a mechanical seal are possible; see examples 3.6.3.2.3. When interpreting received commands the software checks the position of the switch: in the non-verified mode the command set that the software accepts is extended compared to the mode described above; e.g. it may be possible to adjust the calibration factor by a command that is discarded in the verified mode.

### 3.6.6 Separation of software parts

3.6.6.1 All software modules (programs, subroutines, objects, etc.) that perform legally relevant functions or that contain legally relevant data domains form the legally relevant software part of an electricity meter; it shall be made identifiable as described in 3.6.2. If the software modules that perform legally relevant functions are not identified, the whole software shall be considered as legally relevant.

3.6.6.2 If the legally relevant software part communicates with other software parts, a software interface shall be defined. All communication shall be performed exclusively via this interface. The legally relevant software part and the interface shall be clearly documented. All legally relevant functions and data domains of the software shall be described to enable a type approval authority to decide on correct software separation.

3.6.6.3 The data domain forming the software interface including the code that exports from the legally relevant part to the interface data domain and the code that imports from the interface to the legally relevant part shall be clearly defined and documented. The declared software interface shall not be circumvented.

3.6.6.4 There shall be an unambiguous assignment of each command to all initiated functions or data changes in the legally relevant part of the software. Commands that communicate through the software interface shall be declared and documented. Only documented commands are allowed to be activated through the software interface. The manufacturer shall state the completeness of the documentation of commands.

### 3.6.7 Storage of data, transmission via communication systems

#### 3.6.7.1 General

3.6.7.1.1 The measurement value stored or transmitted shall be accompanied by all relevant information necessary for future legally relevant use.

3.6.7.1.2 The data shall be protected by software means to guarantee the authenticity, integrity and, if necessary correctness of the information concerning the time of measurement. The software that displays or further processes the measurement values and accompanying data shall check the time of measurement, authenticity, and integrity of the data after having read them from the insecure storage or after having received them from an insecure transmission channel. If an irregularity is detected, the data shall be discarded or marked unusable.

Confidential keys employed for protecting data shall be kept secret and secured in the electricity meter. Means shall be provided whereby these keys can only be input or read if a seal is broken.

3.6.7.1.3 Software modules that prepare data for storing or sending, or that check data after reading or receiving, belong to the legally relevant software part.

#### 3.6.7.2 Automatic storing

3.6.7.2.1 When data storage is required, measurement data must be stored automatically when the measurement is concluded, i.e. when the final value has been generated. When the final value is from a calculation, all data that are necessary for the calculation must be automatically stored with the final value.

3.6.7.2.2 The storage device must have sufficient permanency to ensure that the data are not corrupted under normal storage conditions. There shall be sufficient memory storage for any particular application.

3.6.7.2.3 Stored data may be deleted if either:

- the transaction is settled;
- these data are printed by a printing device subject to legal control.

3.6.7.2.4 After the requirements in 3.6.7.2.3 are fulfilled and when the storage is full, it is permitted to delete memorized data when both of the following conditions are met:

- data are deleted in the same order as the recording order and the rules established for the particular application are respected;
- deletion is carried out either automatically or after a special manual operation that may require specific access rights.

### 3.6.7.3 Data transmission

3.6.7.3.1 The measurement shall not be inadmissibly influenced by a transmission delay.

3.6.7.3.2 If network services become unavailable, no measurement data shall be lost. The measurement process should be stopped to avoid the loss of measurement data.

### 3.6.7.4 Time stamp

The time stamp shall be read from the clock of the device. Setting the clock is considered as being legally relevant. Appropriate protection means shall be taken according to 3.6.4.

Internal clocks should be enhanced by specific means (e.g. software means) to reduce their uncertainty when the time of measurement is necessary for a specific field (e.g. multi-tariff meter, interval meter).

### 3.6.8 Checking facility event record

If the meter is equipped with a checking facility, the event record of the facility shall have room for at least 100 events (or an alternative number determined by the national authority) and shall be of a first-in-first-out type. The event record may not be changed or zeroed without breaking a seal and/or without authorised access, for example by means of a code (password) or of a special device (hard key, etc.).

## 3.7 Suitability for use

### 3.7.1 Readability of result

The indicating device shall be easy to read and the characters of measurement results shall as minimum be 4 mm high. Any decimal fractions shall be clearly indicated; for mechanical registers, any decimal fraction drum shall be marked differently.

The indicating device shall not be significantly affected by exposure to normal operating conditions over the maximum duration of the meter lifetime.

In the case of multiple values presented by a single indicating device it shall be possible to display the content of all relevant memories. For automatic sequencing displays, each display of register for billing purposes shall be retained for a minimum of 5 s.

For multi-tariff meters, the register which reflects the active tariff shall be indicated. It shall be possible to read each tariff register locally and each register shall be clearly identified.

The register shall be capable of storing and displaying an amount of energy that corresponds to the meter running at  $P = U_{\text{nom}} \cdot I_{\text{max}} \cdot n$  for at least 4000 h, where  $n$  is the number of phases.

Note: The National Authority may change the minimum time required for register rollover.

In the case of electronic registers, the minimum retention time for results is one year for a disconnected meter. Electronic indicating devices shall be provided with a display test.

### 3.7.2 Testability

The meter shall be equipped with a test output for efficient testing, such as a rotor with a mark or a test pulse output. If the design of the test output is such that the pulse rate does not correspond to the measured power in every given relevant time interval, the manufacturer shall declare the necessary number of pulses to ensure a standard deviation of measurement less than 0.1 base m.p.e., at  $I_{\text{max}}$ ,  $I_{\text{tr}}$  and  $I_{\text{min}}$ .

The relation between the measured energy given by the test output and the measured energy given by the indicating device shall comply with the marking on the name-plate.

## 3.8 Durability

The meter shall be designed to maintain an adequate stability of its metrological characteristics over a period of time specified by the manufacturer, provided that it is properly installed, maintained and used according to the manufacturer's instructions when in the environmental conditions for which it is intended.

The meter shall be designed to reduce as far as possible the effect of a defect that would lead to an inaccurate measurement result.

The meter shall be designed and manufactured such that either

- a) Significant durability errors do not occur, or
- b) Significant durability errors are detected and acted upon by means of a durability protection.

~~The manufacturer shall provide at least one of the alternative forms of documentation for the durability of the meter:~~

Formatted: Strikethrough

- ~~a) A description of design measures for durability enhancement or protection~~
- ~~b) Documented experiences based on the operation of meters of similar construction~~
- ~~c) Durability test procedure. The durability test shall be described by the manufacturer. It shall as far as possible relate to international standards and generally accepted procedures.~~

~~Note: Manufacturers' data on durability may be useful for national legislation regarding intervals for subsequent verifications and/or statistical sampling schemes.~~

### 3.9 Presumption of compliance

The type of a meter is presumed to comply with the provisions in Section 3 if it passes the examination and tests specified in Part 2 of this Recommendation.

## Part 2 Metrological controls and performance tests

### 4 Type approval

#### 4.1 Documentation

The documentation submitted with the application for type approval shall include:

- Identification of the type, including
  - name or trademark and type designation
  - version(s) of hardware and software
  - drawing of name plate
- Metrological characteristics of the meter, including
  - a description of the principle(s) of measurement
  - metrological specifications such as accuracy class and rated operating conditions (section 3.1)
  - any steps which should be performed prior to testing the meter.
- The technical specification for the meter, including
  - a block diagram with a functional description of the components and devices,
  - drawings, diagrams and general software information, explaining the construction and operation, including interlocks,
  - description and position of seals or other means of protection,
  - documentation related to durability characteristics,
  - any document or other evidence that the design and construction of the meter complies with the requirements of this recommendation,
  - Specified clock frequency.
- User manual.
- Installation manual
- A description of the checking facility for significant faults, if applicable.

In addition, software documentation shall include:

- a description of the legally relevant software and how the requirements are met:
  - list of software modules that belong to the legally relevant part including a declaration that all legally relevant functions are included in the description;
  - description of the software interfaces of the legally relevant software part and of the commands and data flows via this interface including a statement of completeness;
  - description of the generation of the software identification;
  - depending on the validation method chosen, the source code shall be made available to the testing authority;
  - list of parameters to be protected and description of protection means;
- a description of security means of the operating system (password, etc. if applicable);
- a description of the (software) sealing method(s);
- an overview of the system hardware, e.g. topology block diagram, type of computer(s), type of network, etc.
- where a hardware component is deemed legally relevant or where it performs legally relevant functions, this should also be identified;



- a description of the accuracy of the algorithms (e.g. filtering of A/D conversion results, price calculation, rounding algorithms, etc.);
- a description of the user interface, menus and dialogues;
- the software identification and instructions for obtaining it from an instrument in use;
- list of commands of each hardware interface of the measuring instrument / electronic device / sub-assembly including a statement of completeness;
- list of durability errors that are detected by the software and if necessary for understanding, a description of the detecting algorithms;
- a description of data sets stored or transmitted;
- if fault detection is realized in the software, a list of faults that are detected and a description of the detecting algorithm;
- the operating manual.

Furthermore, if the type approval is to be based on existing type test documentation, the application for type approval shall be accompanied by type test documents or other evidence that supports the assertion that the design and characteristics of the measuring instrument comply with the requirements of this Recommendation.

## 4.2 Type definition

Meters produced by the same manufacturer may form a type provided they have similar metrological properties resulting from the use of the same uniform construction of parts/modules that determine the metrological properties.

A type may have several current ranges and several values of the nominal voltage and frequency, and include several connection modes and several ancillary devices.

Note: The same uniform construction normally means the same construction of the measuring elements, the same construction of metering software, the same construction of the register and indicating device, the same temperature compensation mechanism, the same construction of case, terminal block, and mechanical interface.

### 4.2.1 Type test sampling

The manufacturer shall provide at least as many specimens of the meter as are required by the national authority. The type test shall be made on one or more specimens of the meter, selected by the type test body, to establish its specific characteristics and to prove its conformity with the requirements of this Recommendation. In the case of modifications to the meter made after or during the type test and affecting only part of the meter, the issuing body may deem it sufficient to perform limited tests on the characteristics that may be affected by the modifications.

## 4.3 Validation Procedure

The validation procedure consists of a combination of analysis methods and tests as shown in Table 6. The abbreviations used are described in Table 7

**Table 6. Validation procedures for specified requirements.**

Requirement		Validation procedure
3.6.2	Software identification	AD + VFTSw
3.6.3.1	Prevention misuse	AD + VFTSw
3.6.3.2	Fraud protection	AD + VFTSw + DFA/CIWT/SMT
3.6.4	Parameter protection	AD + VFTSw + DFA/CIWT/SMT
3.6.5	Separation of electronic devices and sub-assemblies	AD
3.6.6	Separation of software parts	AD
3.6.7	Storage of data, transmission via communication systems	AD + VFTSw + CIWT/SMT
3.6.7.1.2	Data protection with respect to time of measurement	AD + VFTSw + SMT
3.6.7.2	Automatic storing	AD + VFTSw
3.6.7.3.1	Transmission delay	AD + VFTSw
3.6.7.3.2	Transmission interruption	AD + VFTSw

3.6.7.4	Time stamp	AD + VFtSw
---------	------------	------------

**Table 7. Validation procedure abbreviations used in Table 6.**

Abbreviation	Description	OIML D 31:2008 Clause
AD	Analysis of the documentation and validation of the design	6.3.2.1
VFTM	Validation by functional testing of metrological functions	6.3.2.2
VFTSw	Validation by functional testing of software functions	6.3.2.3
DFA	Metrological data flow analysis	6.3.2.4
CIWT	Code inspection and walkthrough	6.3.2.5
SMT	Software module testing	6.3.2.6

## 5 Test program

The initial intrinsic error shall be determined as the first test on the meter, as described in 6.2.1.

At the commencement of any series of tests, the meter shall be allowed to stabilize with voltage circuits energised for a period nominated by the manufacturer.

The order of the testpoints shall be from lowest current to highest current and then from highest current to lowest current. For each testpoint, the resulting error shall be the mean of these measurements. For  $I_{max}$ , the maximum measurement time shall be 10 minutes including stabilizing time.

The determination of the intrinsic error (at reference conditions) shall always be carried out before tests of influence quantities and before disturbance tests that relate to a limit of error shift requirement or to a significant fault condition for error.

Otherwise the order of tests is not prescribed in this Recommendation.

Test (pulse) outputs may be used for tests of accuracy requirements. A test must then be made to ensure that the relation between the basic energy register and the used test output complies with the manufacturer's specification.

If a meter is specified with alternate connection modes, such as one-phase connections for poly-phase meters, the tests for base maximum permissible error in accordance with 3.3.3 shall be made for all specified connection modes.

National authorities may prescribe more stringent test regimes than those described in this section.

## 6 Test procedures for type approval

### 6.1 Test conditions

Unless otherwise stated in the individual test instructions, all influence quantities except for the influence quantity being tested shall be held at reference conditions as given by Table 8 during type approval tests.

**Table 8 Reference conditions and their tolerances**

Quantity	Reference conditions	Tolerance
Voltage(s) <sup>(2)</sup>	$U_{nom}$	$\pm 1 \%$
Ambient temperature	$23^{\circ} C^{(1)}$	$\pm 2^{\circ}C$
Frequency	$f_{nom}$	$\pm 0.3 \%$
Wave-form	Sinusoidal	$d \leq 2 \%$
Magnetic induction of external origin at reference frequency	0 T	$B \leq 0.05 \text{ mT}$
Electromagnetic RF fields 30 kHz - 6 GHz	0 V/m	$\leq 1 \text{ V/m}$
Operating position for instruments sensitive to position	Mounting as stated by manufacturer	$\pm 0.5^{\circ}$

Phase sequence for poly-phase meters	L1, L2, L3	-
Load balance	Equal current in all current circuits	$\pm 2\%$ (current) and $\pm 2^\circ$ (phase angle)
<p>(1) Tests may be performed at other temperatures if the results are corrected to the reference temperature by applying the temperature coefficient established in the type tests, and provided an appropriate uncertainty analysis is carried out.</p> <p>(2) The requirement applies to both phase-to-phase and phase-neutral for poly-phase meters</p> <p>Note: The reference conditions and their tolerance are given to ensure reproducibility between testing laboratories, not to determine the accuracy of the tests! The demands on short time stability during test for influence factors may be much higher than shown in this table.</p>		

**Table 9. Load conditions and their tolerances in tests**

Quantity	Conditions	Tolerance
Current(s)	Current range of device under test	Class A,B: $\pm 2\%$ Class C,D: $\pm 1\%$
Power factor	Power factor range of device under test	current to voltage phase difference $\pm 2^\circ$

Note: The load conditions and their tolerance are given to ensure reproducibility between testing laboratories, not to determine the accuracy of the tests! The demands on short time stability during test for influence factors may be much higher than shown in this table.

For most tests, the measured power will be constant if the other influence quantities are kept constant at reference conditions. However, this is not possible for some tests such as influence of voltage variation and load unbalance. Therefore, the error shift shall always be measured as the shift of the relative error and not of the absolute power.

## 6.2 Tests for maximum permissible error

### 6.2.1 Determination of initial intrinsic error

Object of the test: To verify that the error of the meter at reference conditions is less than the relevant base m.p.e. given in Table 2.

Test Procedure: Meters that are specified as being capable of bidirectional or unidirectional energy measurement as described in 3.3.2 shall meet the relevant base m.p.e. requirements of Table 2 for energy flow in both positive and negative directions.

Meters that are specified as capable of measuring only positive energy flow as described in 3.3.2 shall meet the relevant base m.p.e. requirements of Table 2 for positive energy flow. These meters shall also be subjected to reversed energy flow, in response to which the meter shall not register energy in the primary register or emit more than one pulse from the test output. The test time shall be at least 1 minute, or the time that the test output would register ten pulses in the forward energy flow direction, or the time that the primary register would register 2 units of the least significant digit in the forward energy flow direction, whichever is longest.

For reverse running detent designs that are prone to be affected by heating, the test time shall be extended to 10 minutes at  $I_{max}$ .

Mandatory testpoints: Mandatory testpoints are specified in Table 10 for positive, negative and reverse flow tests. National authorities shall select two mandatory testpoints as specified in Table 10.

**Table 10. Mandatory testpoints for the determination of initial intrinsic error test.**

Current	Power Factor	Testpoint mandatory for:		
		Positive flow	Negative flow	Reverse flow
$I_{\min}$	Unity	Yes	No	Yes
A testpoint within range $I_{\min}$ to $I_{tr}$ selected by national authority	Unity	Yes	No	No
	Most inductive <sup>(1)</sup>	Yes	No	No
	Most capacitive <sup>(1)</sup>	Yes	No	No
$I_{tr}$	Unity	Yes	Yes	No
	Most inductive <sup>(1)</sup>	Yes	Yes	No
	Most capacitive <sup>(1)</sup>	Yes	Yes	No
A testpoint within range $I_{tr}$ to $I_{\max}$ selected by national authority	Unity	Yes	No	No
	Most inductive <sup>(1)</sup>	Yes	No	No
	Most capacitive <sup>(1)</sup>	Yes	No	No
$I_{\max}$	Unity	Yes	Yes	Yes
	Most inductive <sup>(1)</sup>	Yes	Yes	No
	Most capacitive <sup>(1)</sup>	Yes	Yes	No

<sup>(1)</sup> Most inductive or capacitive according to Table 1.

### 6.2.2 Continuous maximum current

Object of the test: To verify that the meter is able to carry  $I_{\max}$  continuously as specified in 3.3.3.

Test Procedure: The test shall be carried out as follows: the voltage circuits shall first be energised at reference voltage for at least 1 hour for class A meters and at least 2 hours for meters of all other classes. Then, with the meter otherwise at reference conditions, the maximum current shall be applied to the current circuits. The cable to be used for energizing the meter shall be of copper, have a length of 1 m and a cross-section which ensures that the current density is between 3.2 A/mm<sup>2</sup> and 4 A/mm<sup>2</sup>.

The error of the meter shall be monitored at unity power factor and at intervals short enough to record the curve of error variation as a function of time. The test shall be carried out for at least 1 h, and in any event until the variation of error over any 20-minute period does not exceed 10 % of base maximum permissible error. The error of the meter and the error shift compared to the intrinsic error shall comply with the requirements given in 3.3.3 at all times.

If the error shift has not levelled out at a maximum by the end of the test, the meter shall either be allowed to return to its initial temperature and the entire test repeated at power factor = 0.5 inductive or, if the load can be changed in less than 30 seconds, the error of the meter shall be measured at  $I_{\max}$  and power factor = 0.5 inductive and it shall be checked that the error of the meter and the error shift compared to the intrinsic error comply with the requirements given in 3.3.3.

### 6.2.3 Starting current

Object of the test: To verify that the meter starts and continues to operate at  $I_{st}$  as given by Table 1.

Test Procedure: The meter shall be subjected to a current equal to the starting current  $I_{st}$ . If the meter is designed for the measurement of energy in both directions, then this test shall be applied with energy flowing in each direction. The effect of an intentional delay in measurement after reversal of energy direction should be taken into account when performing the test.

The meter shall be considered to have started if the output produces pulses (or revolutions) at a rate consistent with the base maximum permissible error requirements given by Table 2.

Mandatory testpoints:  $I_{st}$  at unity power factor.

### 6.2.4 Test of no-load condition

Object of the test: To verify the no-load performance of the meter given by Table 2.

Test Procedure: For this test, there shall be no current in the current circuit. The test shall be performed at  $U_{nom}$ .

For meters with a test output, the output of the meter shall not produce more than one pulse. For an electromechanical meter, the rotor of the meter shall not make a complete revolution.

The minimum test period  $\Delta t$  shall be

$$\Delta t \geq \frac{1000}{k \cdot b \cdot U_{nom} \cdot I_{min}} \text{ hours, where}$$

$k$  is the number of pulses emitted by the output device of the meter per kilowatthour (imp/kW·h) or the number of revolutions per kilowatthour (rev/kW·h);

$b$  is the base maximum permissible error at  $I_{min}$ ;

the nominal voltage  $U_{nom}$  is expressed in volts; and

the minimum current  $I_{min}$  is expressed in amperes.

For transformer-operated meters with primary rated registers where the value of  $k$  (and possibly  $U_{nom}$ ) are given as primary side values, the constant  $k$  (and  $U_{nom}$ ) shall be recalculated to correspond to secondary side values (of voltage and current).

### 6.2.5 Meter constants

Object of the test: To verify that the relationship between the basic energy register and the used test output(s) complies with the manufacturer's specification as required in 3.7.2. The relative difference must not be greater than one tenth of the base maximum permissible error. This test is only applicable if test (pulse) outputs are used to test accuracy requirements.

Test Procedure: All registers and pulse outputs that are under legal control must be tested unless a system is in place that guarantees the identical behaviour of all meter constants.

The test shall be performed by passing a quantity of energy  $E$  through the meter, where  $E$  is at least:

$$E_{min} = \frac{R \cdot 10}{\text{base maximum permissible error (\%)}}$$

where  $R$  is the apparent resolution of the basic energy register. The relative difference between the registered energy and the energy passed through the meter as given by the number of pulses from the test output shall be computed.

Allowed effect: The relative difference must not be greater than one tenth of the base maximum permissible error.

Mandatory testpoints: The test shall be performed at a single arbitrary current  $I \geq I_{tr}$ .

Note: Any means may be used to enhance the apparent resolution  $R$  of the basic register, as long as care is taken to assure that the results reflect the true resolution of the basic register.

## 6.3 Tests for influence quantities

### 6.3.1 General

The purpose of these tests is to verify the requirements of section 3.3.3 due to the variation of a single influence quantity. For influence quantities listed in Table 4, it shall be verified that the error shift due to the variation of any single influence quantity is within the corresponding limit of error shift stated in Table 4 (See also the definition of maximum permissible error shift in 2.2.20).

### 6.3.2 Temperature dependence

Object of the test: To verify that the temperature coefficient requirements of [Table 3](#) and the error shift requirements of Table 4 are fulfilled.

Deleted: Table 3

Test Procedure: For each testpoint, the error of the meter shall be determined at the reference temperature and at each of the upper and lower ambient temperature limits specified for the meter.

Deleted: R46CD5 (30 July 2010)

The error shift, relative to the intrinsic error at 23 degrees Celsius, shall be computed for each of the above temperatures and must comply with the requirements of Table 4.

Furthermore, for each testpoint and for each temperature interval given by adjacent upper or lower temperature limits including the reference temperature, the (mean) temperature coefficient,  $c$ , shall be determined as follows:

$$c = \frac{e_u - e_l}{t_u - t_l}$$

where  $e_u$  and  $e_l$  are the errors at the uppermost and the lowest temperatures respectively in the temperature interval of interest; and

$t_u$  and  $t_l$  are the uppermost and the lowest temperatures respectively in the temperature interval of interest.

Each temperature coefficient must be in accordance with the requirements of [Table 3](#).

Deleted: Table 3

Mandatory testpoints: The test shall, at minimum, be performed at PF = 1 and PF = 0.5 inductive and for currents of  $I_{tr}$ ,  $10 I_{tr}$  and  $I_{max}$ .

### 6.3.3 Load balance

Object of the test: To verify that the error shift due to load balance complies with the requirements of Table 4. This test is only for poly-phase meters and for single-phase three-wire meters.

Test procedure: The error of the meter with current in one current circuit only shall be measured and compared to the intrinsic error at balanced load. During the test, reference voltages shall be applied to all voltage circuits.

Mandatory testpoints: The test shall be performed for all current circuits at PF = 1 and PF = 0.5 inductive, and, at minimum, for currents of  $10 I_{tr}$  and  $I_{max}$  for direct connected meters, and, at minimum, at  $I_{max}$  for transformer operated meters.

### 6.3.4 Voltage variation

Object of the test: To verify that the error shift due to voltage variations complies with the requirements of Table 4.

Test Procedure: The error shift, compared to the intrinsic error at  $U_{nom}$ , shall be measured when the voltage is varied within the corresponding rated operating range. For poly-phase meters, the test voltage shall be balanced. If several  $U_{nom}$  values are stated, the test shall be repeated for each  $U_{nom}$  value.

Mandatory testpoints: The test shall, at minimum, be performed at PF = 1 and PF = 0.5 inductive, for a current of  $10 I_{tr}$ , and at voltages  $0.9 U_{nom}$  and  $1.1 U_{nom}$ .

### 6.3.5 Frequency variation

Object of the test: To verify that the error shift due to frequency variations complies with the requirements of Table 4.

Test Procedure: The error shift, compared to the intrinsic error at  $f_{nom}$ , shall be measured when the frequency is varied within the corresponding rated operating range. If several  $f_{nom}$  values are stated, the test shall be repeated with each  $f_{nom}$  value.

Mandatory testpoints: The test shall, at minimum, be performed at PF = 1 and PF = 0.5 inductive, for a current of  $10 I_{tr}$ , and at frequencies of  $0.98 f_{nom}$  and  $1.02 f_{nom}$ .

### 6.3.6 Harmonics in voltage and current

Object of the test: To verify that the error shift due to harmonics complies with the requirements

Test Procedure: The error shift, compared to the intrinsic error at sinusoidal conditions, shall be measured when harmonics are added in both the voltage and the current. The test shall be performed using the quadriform and peaked waveforms specified in Table 11 and Table 12 respectively. The amplitude of a single harmonic shall not be more than  $0.12 U_1/h$  for voltage and  $I_1/h$  for the current, where  $h$  is the harmonic number and  $U_1$  and  $I_1$  are the respective fundamentals. Plots of the current amplitude for the waveforms in Table 11 and Table 12 are shown in Figure 1 and Figure 2 respectively.

Deleted: R46CD5 (30 July 2010)

The r.m.s. current may not exceed  $I_{max}$ , i.e. for Table 11, the fundamental current component  $I_1$  may not exceed  $0.93 I_{max}$ . The peak value of the current may not exceed  $1.4 I_{max}$ , i.e. for Table 12, the fundamental current component  $I_1$  (r.m.s.) may not exceed  $0.568 I_{max}$ .

Harmonic amplitudes are calculated relative to the amplitude of the fundamental frequency component of the voltage or current respectively. Phase angle is calculated relative to the zero-crossing of the fundamental frequency voltage or current component respectively.

Mandatory testpoints: The test shall, at minimum, be performed at  $10 I_U$ , PF = 1, where the power factor is given for the fundamental component.

**Table 11. Quadriform waveform**

Harmonic number	Current amplitude	Current phase angle	Voltage amplitude	Voltage phase angle
1	100 %	0 °	100 %	0 °
3	30 %	0 °	3.8 %	180 °
5	18 %	0 °	2.4 %	180 °
7	14 %	0 °	1.7 %	180 °
11	9 %	0 °	1.0 %	180 °
13	5 %	0 °	0.8 %	180 °

**Table 12. Peaked waveform**

Harmonic number	Current amplitude	Current phase angle	Voltage amplitude	Voltage phase angle
1	100 %	0 °	100 %	0 °
3	30 %	180 °	3.8 %	0 °
5	18 %	0 °	2.4 %	180 °
7	14 %	180 °	1.7 %	0 °
11	9 %	180 °	1.0 %	0 °
13	5 %	0 °	0.8 %	180 °

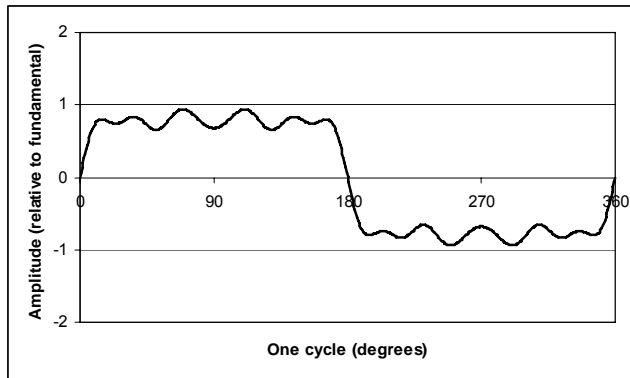

**Figure 1. Current amplitude for quadriform waveform.**

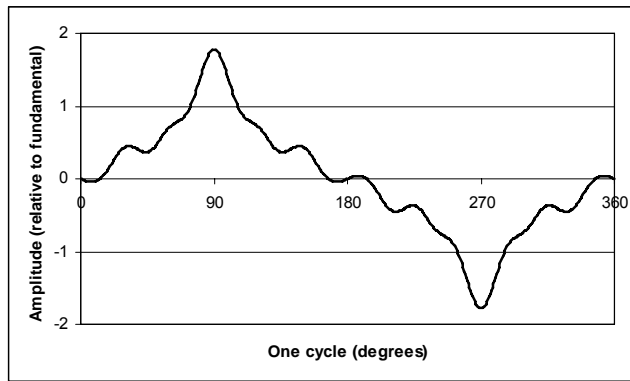

**Figure 2. Current amplitude for peaked waveform.**

### 6.3.7 Tilt

**Object of the test:** To verify that the error shift due to tilt complies with the requirements of Table 4. This test is only for electromechanical meters or meters of other constructions that may be influenced by the working position.

**Test Procedure:** The error shift, compared to the intrinsic error at the operating position given by the manufacturer, shall be measured when the meter is tilted from its ideal position to an angle 3 degree from that position.

**Mandatory testpoints:** The test shall, at minimum, be performed at  $I_{tr}$ , PF = 1 and at two perpendicular tilting angles.

### 6.3.8 Severe voltage variations

**Object of the test:** To verify that the error shift due to severe voltage variations complies with the requirements of Table 4.

**Test procedure 1:** The intrinsic error shall first be measured at  $U_{nom}$ . It shall be then verified that the error shift, relative to the intrinsic error at  $U_{nom}$  complies with the requirements of Table 4 when the voltage is varied from  $0.8 U_{nom}$  to  $0.9 U_{nom}$  and from  $1.1 U_{nom}$  to  $1.15 U_{nom}$ . For poly-phase meters, the test voltage shall be balanced. If several  $U_{nom}$  values are stated, the test shall be repeated for each  $U_{nom}$  value.

**Mandatory testpoints 1:** The test shall, at minimum, be performed at  $10 I_{tr}$ , PF = 1 and for voltages of  $0.8 U_{nom}$ ,  $0.85 U_{nom}$  and  $1.15 U_{nom}$ .

**Test procedure 2:** Further, the error shift, compared to the intrinsic error at  $U_{nom}$ , shall be measured when the voltage is varied from  $0.8 U_{nom}$  down to 0.

**Mandatory testpoints 2:** The test shall, at minimum, be performed at  $10 I_{tr}$ , PF = 1 and for voltages of  $0.70 U_{nom}$ ,  $0.6 U_{nom}$ ,  $0.50 U_{nom}$ ,  $0.40 U_{nom}$ ,  $0.30 U_{nom}$ ,  $0.20 U_{nom}$ ,  $0.10 U_{nom}$ , and 0 V.

If the meter has a distinct shut-down voltage, then mandatory testpoints shall include one point above and one point below the shut-down voltage. The lower testpoint shall be within a 2 V range below the shut-down voltage. The upper testpoint shall be within a 2 V range above the turn-on voltage.

### 6.3.9 One or two phases interrupted

**Object of the test:** To verify that the error shift due to one or two phases interrupted complies with the requirements of Table 4. The test is only for poly-phase meters with three measuring elements.

**Test Procedure:** The error shift, compared to the intrinsic error at balanced voltage and load current conditions, shall be measured when one or two of the phases are removed while keeping the load current constant. Two phases interrupted is only for those connection modes where a missing phase means that there can be no energy delivered. A poly-phase meter which is powered from only one of its phases shall not have the voltage of that phase interrupted for the purposes of this test.



Mandatory testpoints: The test shall, at minimum, be performed at  $10 I_{tr}$ , with one or two of the phases removed in combinations such that each phase has been removed at least once.

### 6.3.10 Sub-harmonics in the AC current circuit

Object of the test: To verify that the error shift due to sub-harmonics complies with the requirements of Table 4.

Test Procedure: The error shift, compared to the intrinsic error at sinusoidal conditions, shall be measured when the sinusoidal reference current is replaced by another sinusoidal signal with twice the peak value, and which is switched on and off every second period as shown by Figure 3 a) and b). (The measured power should then be the same as for the original sinusoidal signal while the r.m.s. current is 1.41 times higher). Care should be taken that no significant DC current is introduced. During the test, the peak value of the current shall not exceed  $1.4 I_{max}$ .

Mandatory testpoints: The test shall, at minimum, be performed at a reference current of  $10 I_{tr}$ , PF = 1.

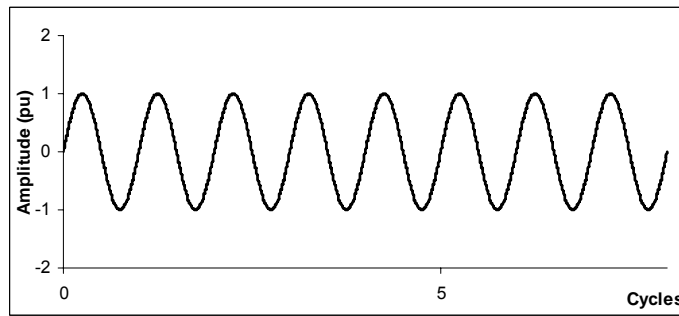

a) Continuous test current for intrinsic error.

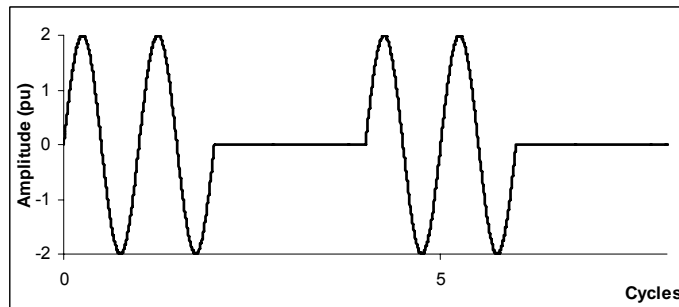

b) Sub-harmonic test current 2 cycles on, 2 cycles off

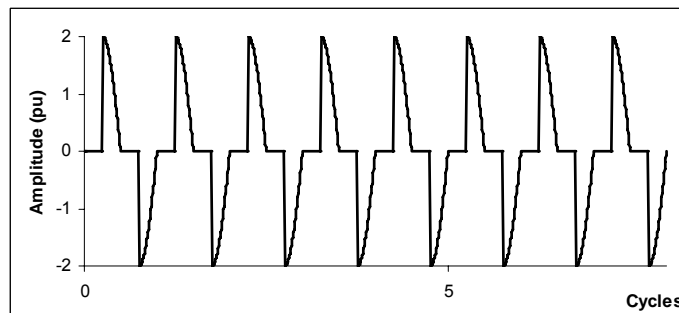

c) Harmonic test current, zero current during phase angles of 0-90° and 180-270°.

Figure 3. Test currents for sub-harmonics and harmonics tests.

### 6.3.11 Harmonics in the AC current circuit

Object of the test: To verify that the error shift due to harmonics in the AC current circuit complies with the requirements of Table 4.

Test Procedure: The error shift, compared to the intrinsic error at sinusoidal conditions, shall be measured when the sinusoidal reference current as shown in Figure 3 a) is replaced by a current with twice the original peak value where the sinusoidal waveform is set to zero during the first and third quarters of the period as shown by Figure 3 c). The measured power should then be the same as for the original sinusoidal signal while the r.m.s. current is 1.41 times higher. During the test, the peak value of the current shall not exceed  $1.4 I_{\max}$ .

Mandatory testpoints: The test shall, at minimum, be performed at a reference current of  $10 I_{tr}$ , PF = 1. Additional testpoints may be specified by national authorities.

### 6.3.12 Reversed phase sequence (any two phases interchanged)

Object of the test: To verify that the error shift due to interchanging any two of the three phases complies with the requirements of Table 4. This test only applies to three-phase meters.

- Test Procedure: The error shift, compared to the intrinsic error at reference conditions, shall be measured when any two of the three phases are interchanged.
- Mandatory testpoints: The test shall, at minimum, be performed at a reference current of  $10 I_{tr}$ , PF = 1 with any two of the three phases interchanged. Additional testpoints may be specified by national authorities.

### 6.3.13 Continuous (DC) magnetic induction of external origin

- Applicable standard: None.
- Object of the test: To verify that the error shift due to continuous (DC) magnetic induction of external origin complies with the requirements of Table 4.
- Test Procedure: The error shift, compared to the intrinsic error at reference conditions, shall be measured when the meter is subjected to continuous magnetic induction with a probe in the form of a permanent magnet with a surface area of at least 2000 mm<sup>2</sup>. The magnetic field along the axis of the magnet's core shall comply with details specified in Table 13.
- Mandatory testpoints: 6 points per meter surface. The test shall, at minimum, be performed at  $10 I_{tr}$ , PF = 1. The greatest error shift is to be noted as the test result.

**Table 13. Specifications of the field along axis of the magnet's core**

Distance from magnet surface	Magnetic induction	Tolerance
30 mm	200 mT	±30 mT

Note: Neodymium or niobium permanent magnets are recommended for this test.

### 6.3.14 Magnetic field (AC, power frequency) of external origin

- Applicable standard: IEC 61000-4-8.
- Object of the test: To verify that the error shift due to an AC magnetic field at power frequency complies with the requirements of Table 4.
- Test procedure in brief: The error shift, compared to the intrinsic error at reference conditions, shall be measured when the meter is exposed to a magnetic field at the power frequency ( $f = f_{nom}$ ).
- Test severity: Continuous field, 400 A/m.
- Mandatory testpoints: The test shall, at minimum, be performed at  $10 I_{tr}$  and at  $I_{max}$ , PF = 1 and with the magnetic field at three orthogonal directions.

### 6.3.15 Electromagnetic fields

#### 6.3.15.1 Radiated, radio frequency (RF), electromagnetic fields

- Applicable standard: IEC 61000-4-3.
- Object of the test: To verify that the error shift due to radiated, radio frequency, electromagnetic fields complies with the requirements of Table 4. Meters, such as electromechanical meters, which have been constructed using only passive elements shall be assumed to be immune to radiated radiofrequency fields. Note, test condition 2 below corresponds to the disturbance test of 6.4.6.
- Test Procedure in brief: The error shift, compared to the intrinsic error at sinusoidal conditions, shall be measured when the meter is subjected to electromagnetic RF fields. The electromagnetic field strength shall be as specified by the severity level and the field uniformity shall be as defined by the standard referenced. The frequency ranges to be considered are swept with the modulated signal, pausing to adjust the RF signal level or to switch oscillators and antennas as necessary. Where the frequency range is swept incrementally, the step size shall not exceed 1 % of the preceding frequency value. The test time for a 1 % frequency change shall not be less than the time to make a measurement and in any case not less than 0.5 s.
- The cable length exposed to the electromagnetic field shall be 1 m.
- The test shall be performed with the generating antenna facing each side of the meter. When the meter can be used in different orientations (i.e. vertical or horizontal) all sides shall be exposed to the fields during the test.

The carrier shall be modulated with 80 % AM at 1 kHz sine wave.

The meter shall be separately tested at the manufacturer's specified clock frequency.

Any other sensitive frequencies shall also be analyzed separately.

Note: Usually these sensitive frequencies can be expected to be the frequencies emitted by the meter.

The meter shall be tested as a table top instrument under two test conditions, where test condition 2 corresponds to the disturbance test of 6.4.6:

**Test Condition 1:** During the test, the meter shall be energized with reference voltage and a current equal to  $10 I_{tr}$ . The measurement error of the meter shall be monitored by comparison with a reference meter not exposed to the electromagnetic field or immune to the field, or by an equally suitable method. The error at each 1% incremental interval of the carrier frequency shall be monitored and compared to the requirements of Table 4. When using a continuous frequency sweep, this can be accomplished by adjusting the ratio of the sweep time and the time of each measurement. When using incremental 1% frequency steps, this can be accomplished by adjusting the dwell time on each frequency to fit the measurement time.

**Test Condition 2:** During the test, the voltage and auxiliary circuits of the meter shall be energized with reference voltage. There should be no current in the current circuits and the current terminals shall be open-circuited.

Note: Test Condition 2 corresponds to the disturbance test of 6.4.6, therefore the general instructions of 6.4.1 also apply.

Test severities: As defined in Table 14.

**Table 14. Severity of test**

For Test Condition	Frequency range	Field strength
Test Condition 1 (with current)	80 – 6000 MHz	10 V/m
Test Condition 2 (without current)	80 – 6000 MHz	30 V/m

### 6.3.15.2 Immunity to Conducted Disturbances, Induced by Radiofrequency Fields

Applicable standard: IEC 61000-4-6.

**Object of the test:** To verify that the error shift due to conducted disturbances, induced by RF fields complies with the requirements of Table 4. Meters, such as electromechanical meters, which have been constructed using only passive elements shall be assumed to be immune to conducted disturbances induced by RF fields.

**Test procedure in brief:** A radiofrequency electromagnetic current to simulate the influence of electromagnetic fields shall be coupled or injected into the power ports and I/O ports of the meter using coupling/decoupling devices as defined in the standard referenced. The performance of the test equipment consisting of an RF generator, (de)coupling devices, attenuators, etc. shall be verified.

The meter shall be tested as a tabletop instrument. During the test, the meter shall be energized with reference voltage and a current equal to  $10 I_{tr}$ . The error at each 1% incremental interval of the carrier frequency shall be monitored and compared to the requirements of Table 4. When using a continuous frequency sweep, this can be accomplished by adjusting the ratio of the sweep time and the time of each measurement. When using incremental 1% frequency steps, this can be accomplished by adjusting the dwell time on each frequency to fit the measurement time.

If the meter is a poly-phase meter, the tests shall be performed at all extremities of the cable.

**Test severity:** RF amplitude (50 Ohm): 10 V (e.m.f.)  
 Frequency range: 0.15 – 80 MHz  
 Modulation: 80 % AM, 1 kHz sine wave

### 6.3.16 DC in the AC current circuit

- Object of the test: To verify that the error shift due to DC in the AC current circuit complies with the requirements of Table 4. Electromechanical and transformer operated meters shall be assumed to be immune to DC in the AC current circuit.
- Test procedure: The error shift, compared to the intrinsic error at sinusoidal conditions, shall be measured when the current amplitude is increased to twice its value and is half-wave rectified.
- Mandatory testpoints: The test shall be performed at  $I = I_{\max} / \sqrt{2}$ , PF = 1, where  $I$  is the current through the standard meter.

Note: The half-wave rectification and measurement can be performed as shown in Figure 4 (only the current path is shown, the voltage shall be connected as normal). The uncertainty of measurement in this method is very dependent on the (sub-period) output impedance of the current source and the current circuit impedance of the standard meter in combination with the possible impedance differences of the two current branches.

NB: Since the uncertainty is dependent on the absolute branch impedance difference and not the relative (if not  $R_{\text{balancing}} \gg R_{\text{source}}$ ), the problem can generally not be remedied by introducing additional matched resistors in each branch. It can, however, be monitored by studying the DC current from the source. The DC components should not be higher than 0.5 to 1 % of the AC value. (When measuring a DC component in the order of 1 % of the AC component, the instrument should preferably be calibrated beforehand by a measurement of the test current with the test circuit diodes disconnected and short-circuited.)

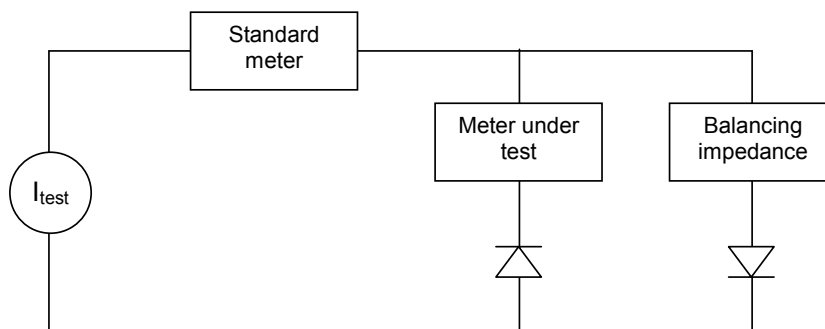

Figure 4. Proposed current test circuit for DC and even harmonic test (only one-phase current circuit shown, voltage to be connected as normal)

### 6.3.17 High-order harmonics

- Object of the test: To verify that the error shift due to high-order harmonics complies with the requirements of Table 4. Furthermore, the function of the meter shall not be impaired.
- Test procedure: The error shift, compared to the intrinsic error at sinusoidal conditions, shall be measured when asynchronous test signals, swept from  $f = 15 f_{\text{nom}}$  to  $50 f_{\text{nom}}$ , are superimposed first on the signal to the voltage circuits and then on the signal to the current circuits. In the case of a poly-phase meter all voltage or current circuits may be tested at the same time. The signal frequency shall be swept from low frequency to high frequency and back down while the metering error is measured.
- Test severity: The asynchronous signal shall have a value of  $0.02 U_{\text{nom}}$  and  $0.1 I_{\text{tr}}$ , with a tolerance of  $\pm 5\%$ .
- Mandatory testpoints: The test shall be performed at  $I_{\text{tr}}$ . During the test, the sweep time of the test shall be adjusted so that at least 100 accurate readings of the meter error are made during each sweep.

## 6.4 Tests for disturbances

### 6.4.1 General instructions for disturbance tests

These tests are to verify that the meter fulfils the requirements for the influence of disturbances as given by Table 5. Tests are to be performed using one disturbance at a time; all other influence quantities shall be set to reference conditions unless otherwise stated in the relevant test description. No significant fault shall occur. Unless otherwise stated, each test shall include:

- a check that any change in the registers or equivalent energy of the test output is less than the critical change value given in 3.3.5.2,
- an operational check to verify that the meter registers energy when subjected to current,

- c) a check for correct operation of pulse outputs and tariff change inputs, if present; and
- d) confirmation by measurement that the meter still fulfils the base maximum permissible error requirements after the disturbance test.

Temporary loss of functionality is allowed as long as the meter returns to normal functionality automatically when the disturbance is removed.

The mandatory testpoints for the check of base maximum permissible error are:

- 1)  $I_{tr}$ , PF = 1,
- 2)  $10 I_{tr}$ , PF = 0.5 inductive.

#### 6.4.2 Magnetic field (AC, power frequency) of external origin

Applicable standard: IEC 61000-4-8.

Object of the test: To verify compliance with the requirements of 3.3.5.2 and Table 5 under conditions of an AC magnetic field at power frequency of external origin.

Test procedure in brief: The meter shall be connected to reference voltage but with no current in the current circuits. The magnetic field shall be applied along three orthogonal directions.

Allowed effects: No significant fault shall occur.

Test severity: Magnetic field strength short duration (3 s): 1000 A/m

#### 6.4.3 Electrostatic discharge

Applicable standard: IEC 61000-4-2.

Object of the test: To verify compliance with the requirements of 3.3.5.2 and Table 5 under conditions of direct and indirect electrostatic discharge. Meters, such as electromechanical meters, which have been constructed using only passive elements shall be assumed to be immune to electrostatic discharges.

Test procedure in brief: An ESD generator shall be used with performance characteristics specified in the referenced standard. Before starting the tests, the performance of the generator shall be verified. At least 10 discharges, in the most sensitive polarity, shall be applied. For a meter not equipped with a ground terminal, the meter shall be fully discharged between discharges. Contact discharge is the preferred test method. Air discharges shall be used where contact discharge cannot be applied.

Direct application: In the contact discharge mode to be carried out on conductive surfaces, the electrode shall be in contact with the meter. In the air discharge mode on insulated surfaces, the electrode is approached to the meter and the discharge occurs by spark.

Indirect application: The discharges are applied in the contact mode to coupling planes mounted in the vicinity of the meter.

Test conditions: The test shall be done with the meter in operating condition. The voltage circuits shall be energised with  $U_{nom}$  and the current and auxiliary circuits shall be open, without any current. The meter shall be tested as table-top equipment.

Allowed effects: No significant fault shall occur.

Test severity: Contact discharge voltage <sup>(1)</sup>: 6 kV  
Air discharge voltage <sup>(2)</sup>: 8 kV

Note (1): Contact discharges shall be applied on conductive surfaces.

Note (2): Air discharges shall be applied on non-conductive surfaces.

#### 6.4.4 Fast transients

Applicable standards: IEC 61000-4-1, IEC 61000-4-4.

Object of the test: To verify compliance with the requirements of 3.3.5.2 and Table 5 under conditions where electrical bursts are superimposed on voltage and current circuits, and I/O and communication ports. Meters, such as electromechanical meters, which have been constructed using only passive elements shall be assumed to be immune to fast transients.

**Test procedure in brief:** A burst generator shall be used with the performance characteristics specified in the referenced standard. The meter shall be subjected to bursts of voltage spikes for which the repetition frequency of the impulses and peak values of the output voltage on 50 Ohm and 1000 Ohm loads are defined in the referenced standard. The characteristics of the generator shall be verified before connecting the meter. Both positive and negative polarity bursts shall be applied. The duration of the test shall not be less than 1 min for each amplitude and polarity. A capacitive coupling clamp, as defined in the standard, shall be used to couple to I/O and communication lines with a reference voltage over 40 V. The test pulses shall be applied continuously during the measurement time.

**Test conditions:** The meter shall be tested as table top equipment  
 The meter voltage and auxiliary circuits shall be energised with reference voltage  
 The cable length between the coupling device and the meter shall be 1 m.  
 The test voltage shall be applied in common mode (line-to-earth) to:

- a) the voltage circuits;
- b) the current circuits, if separated from the voltage circuits in normal operation;
- c) the auxiliary circuits, if separated from the voltage circuits in normal operation and with a reference voltage over 40 V.

**Test severity:** Test voltage on the current and voltage circuits: 4 kV.  
 Test voltage on auxiliary circuits with a reference voltage over 40 V: 2 kV.

**Allowed effects:** The function of the meter shall not be perturbed, and the error shift, compared to the intrinsic error at reference conditions, shall be less than that given for the relevant meter class in Table 5

**Mandatory testpoints:**  $10 I_{tr}$ , PF = 1.

**6.4.5 Voltage dips and interruptions**

**Applicable standards:** IEC 61000-4-11, IEC 61000-6-1, IEC 61000-6-2.

**Object of the test:** To verify compliance with the requirements of 3.3.5.2 and Table 5 under conditions of short time mains voltage reductions (dips and interruptions). Meters, such as electromechanical meters, which have been constructed using only passive elements shall be assumed to be immune to voltage dips and interruptions.

**Test procedure in brief:** A test generator, which is able to reduce the amplitude of the AC mains voltage over an operator-defined period of time, should be used in this test. The performance of the test generator shall be verified before connecting the meter.

The mains voltage reductions shall be repeated 10 times with an interval of at least 10 seconds.

**Test conditions:** Voltage circuits energized with  $U_{nom}$   
 Without any current in the current circuits.

**Test severities:** Voltage dips:

Test	Test a	Test b	Test c
Reduction:	30 %	60 %	60 %
Duration:	0.5 cycles	1 cycle	25 cycles (50 Hz) 30 cycles (60 Hz)

Voltage interruption test:

Reduction:	0 %
Duration:	250 cycles (50 Hz) 300 cycles (60 Hz)

**Allowed effect:** No significant fault shall occur.

#### 6.4.6 Radiated, radio frequency (RF), electromagnetic fields

Applicable standard: IEC 61000-4-3

Object of the test: To verify compliance with the requirements of 3.3.5.2 and Table 5 under conditions of radiated, radio frequency, electromagnetic fields. Meters, such as electromechanical meters, which have been constructed using only passive elements shall be assumed to be immune to radiated radiofrequency fields.

Test Procedure: Refer to 6.3.15.1 for test procedure.

Allowed effects: No significant fault shall occur.

#### 6.4.7 Surges on AC mains power lines

Applicable standard: IEC 61000-4-5.

Object of the test: To verify compliance with the requirements of 3.3.5.2 and Table 5 under conditions where electrical surges are superimposed on the mains voltage and, if applicable, on I/O and communication ports. This test is not applicable for meters such as electromechanical meters which shall be assumed to be immune to surges.

Test procedure in brief: A surge generator shall be used with the performance characteristics specified in the referenced standard. The test consists of exposure to surges for which the rise time, pulse width, peak values of the output voltage/current on high/low impedance load, and minimum time interval between two successive pulses are defined in the referenced standard.

The characteristics of the generator shall be verified before connecting the meter.

Test conditions: meter in operating condition;  
voltage circuits energized with nominal voltage;  
without any current in the current circuits and the current terminals shall be open;  
cable length between surge generator and meter: 1 m;  
tested in differential mode (line to line);  
phase angle: pulses to be applied at 60° and 240° relative to zero crossing of AC supply;

Test severities: Voltage circuits:

- Line to line: Test voltage: 2.0 kV, generator source impedance: 2 Ω
- Line to earth<sup>(1)</sup>: Test voltage: 4.0 kV, generator source impedance: 2 Ω
- Number of tests: 5 positive and 5 negative
- Repetition rate: maximum 1/min.

Auxiliary circuits with a reference voltage over 40 V:

- Line to line: Test voltage 1.0 kV, generator source impedance 42 Ω
- Line to earth<sup>(1)</sup>: Test voltage 2.0 kV, generator source impedance 42 Ω
- Number of tests: 5 positive and 5 negative
- Repetition rate: maximum 1/min.

(1): For cases where the earth of the meter is separate to neutral.

#### 6.4.8 Damped oscillatory waves immunity test

Applicable standard: IEC 61000-4-12.

Object of the test: To verify compliance with the requirements of 3.3.5.2 and Table 5 under conditions of damped oscillatory waves. This test is only for meters intended to be operated with voltage transformers.

Test procedure in brief: The meter is subjected to damped oscillatory voltage waveforms with a peak voltage according to the test severity stated below.

Test Conditions: Meters shall be tested as table top equipment;



Meters shall be in operating condition;  
 Voltage circuits energized with nominal voltage;  
 With  $I = 20 I_{tr}$  and power factor one and 0.5 inductive;

Test severities: Test voltage on voltage circuits and auxiliary circuits with an operating voltage  $> 40 V$ :

- common mode: 2.5 kV;
- differential mode: 1.0 kV;

Test frequencies:

- 100 kHz, repetition rate: 40 Hz;
- 1 MHz, repetition rate: 400 Hz;

Test duration: 60 s (15 cycles with 2 s on, 2 s off, for each frequency)

Allowed effects: During the test the function of the meter shall not be perturbed and the error shift shall be less than the limits given in Table 5.

Mandatory testpoints:  $20 I_{tr}$ , PF = 1 and 0.5 inductive

#### 6.4.9 Short-time overcurrent

Object of the test: To verify compliance with the requirements of 3.3.5.2 and Table 5 under conditions of a short time overcurrent.

Test procedure in brief: The meter shall be able to handle the current caused by a short-circuit within the load being metered, when that load is protected with the proper fuses or breakers.

Test current: For direct connected meters:  $30 \cdot I_{max} +0 \% -10\%$ , for one half cycle at rated frequency or equivalent. For meters connected through current transformers: A current equivalent to  $20 \cdot I_{max} +0 \% -10\%$ , for 0.5 s.

The test current shall be applied to one phase at the time. The test current value given is the r.m.s. value, not the peak value.

Allowed effects: No damage shall occur. With the voltage still connected the meter shall be allowed to return to normal temperatures (about one hour). The error shift, compared to the initial error before the test, shall then be less than the limit of error shift given by Table 5.

Mandatory test points:  $10 I_{tr}$ , PF = 1.

#### 6.4.10 Impulse voltage

##### 6.4.10.1 General

Object of the test: To verify compliance with the requirements of 3.3.5.2 and Table 5 under conditions of impulse voltage.

General test procedure: The meter and its incorporated auxiliary devices, if any, shall be such that they retain adequate dielectric qualities, taking account of the atmospheric influences and different voltages to which they are subjected under normal conditions of use.

The meter shall withstand the impulse voltage test as specified below. The test shall be carried out only on complete meters.

For the purpose of this test, the term “earth” has the following meaning:

- a) when the meter case is made of metal, the “earth” is the case itself, placed on a flat, conducting surface;
- b) when the meter case or only part of it is made of insulating material, the “earth” is a conductive foil wrapped around the meter touching all accessible conductive parts and connected to the flat, conducting surface on which the meter is placed. The distances between the conductive foil and the terminals, and between the conductive foil and the holes for the conductors, shall be no more than 2 cm.

During the impulse voltage test, the circuits that are not under test shall be connected to the earth.

General test conditions: ambient temperature:  $15\text{ }^{\circ}\text{C}$  to  $25\text{ }^{\circ}\text{C}$ ;

[R46CD5A \(17 September 2010\)](#)

relative humidity: 25 % to 75 %;  
atmospheric pressure: 86 kPa to 106 kPa.

Allowed effects: After completion of the impulse voltage test, there shall be no damage to the meter and no significant fault shall occur.

#### 6.4.10.2 Impulse Voltage Test Procedure

Applicable standard: The test shall be performed as defined in IEC 61000-4-5

Test Conditions: impulse waveform: 1.2/50  $\mu$ s impulse specified in IEC 60060-1;

voltage rise time:  $\pm 30$  %;

voltage fall time:  $\pm 20$  %;

source energy: 10.0 J  $\pm 1.0$  J;

test voltage: in accordance with Table 15;

test voltage tolerance: +0 –10 %.

For each test the impulse voltage is applied ten times with one polarity and then repeated ten times with the other polarity. The minimum time between impulses shall be 30 s.

**Table 15. Impulse voltage test levels**

Voltage phase to earth derived from rated system voltage (V)	Rated impulse voltage (V)
$V \leq 100$	3 000
$100 \leq V \leq 150$	6 000
$150 \leq V \leq 300$	10 000
$300 < V \leq 600$	12 000
Note: National authority may change the applicable rated impulse voltage levels.	

#### 6.4.10.3 Impulse voltage tests for circuits and between circuits

Test Procedure: The test shall be made independently on each circuit (or assembly of circuits) which is insulated from other circuits of the meter in normal use. The terminals of the circuits which are not subjected to impulse voltage shall be connected to earth.

Thus, when the voltage and current circuits of a measuring element are connected together in normal use, the test shall be made on the whole. The other end of the voltage circuit shall be connected to earth and the impulse voltage shall be applied between the terminal of the current circuit and earth. When several voltage circuits of a meter have a common point, this point shall be connected to earth and the impulse voltage successively applied between each of the free ends of the connections (or the current circuit connected to it) and earth. The other end of this current circuit shall be open.

When the voltage and current circuits of the same measuring element are separated and appropriately insulated in normal use (e.g. each circuit connected to measuring transformer), the test shall be made separately on each circuit.

During the test of a current circuit, the terminals of the other circuits shall be connected to earth and the impulse voltage shall be applied between one of the terminals of the current circuit and earth. During the test of a voltage circuit, the terminals of the other circuits and one of the terminals of the voltage circuit under test shall be connected to earth and the impulse voltage shall be applied between the other terminal of the voltage circuit and earth.

The auxiliary circuits intended to be connected either directly to the mains or to the same voltage transformers as the meter circuits, and with a reference voltage over 40 V, shall be subjected to the impulse voltage test by being tied together with a voltage circuit during tests. The other auxiliary circuits shall not be tested.

#### 6.4.10.4 Impulse voltage test of electric circuits relative to earth

Test procedure: All the terminals of the electric circuits of the meter, including those of the auxiliary circuits with a reference voltage over 40 V, shall be connected together.

The auxiliary circuits with a reference voltage below or equal to 40 V shall be connected to earth. The impulse voltage shall be applied between all the electric circuits and earth.

Allowed effects: During this test no flashover, disruptive discharge or puncture shall occur.

#### 6.4.11 Earth fault

Object of the test: To verify compliance with the provisions of 3.3.5.2 and Table 5 under conditions of earth fault.

This test only applies to three-phase four-wire transformer-operated meters connected to distribution networks which are equipped with earth fault neutralizers or in which the star point is isolated. In the case of an earth fault and with 10% overvoltage, the line-to-earth voltages of the two lines which are not affected by the earth fault will rise to 1.9 times the nominal voltage.

Test Procedure: The following test requirements apply:

For a test under a simulated earth fault condition in one of the three lines, all voltages are increased to 1.1 times the nominal voltages during 4 hours. The neutral terminal of the meter under test is disconnected from the ground terminal of the meter test equipment (MTE) and is connected to the MTE's line terminal at which the earth fault has to be simulated (see Figure 5). In this way, the two voltage terminals of the meter under test which are not affected by the earth fault are connected to 1.9 times the nominal phase voltages.

Allowed effects: After the test, the meter shall show no damage and shall operate correctly. The change of error measured when the meter is back at nominal working temperature shall not exceed the limits given in Table 5.

Mandatory testpoints:  $10 I_{tr}$ , power factor = 1, balanced load.

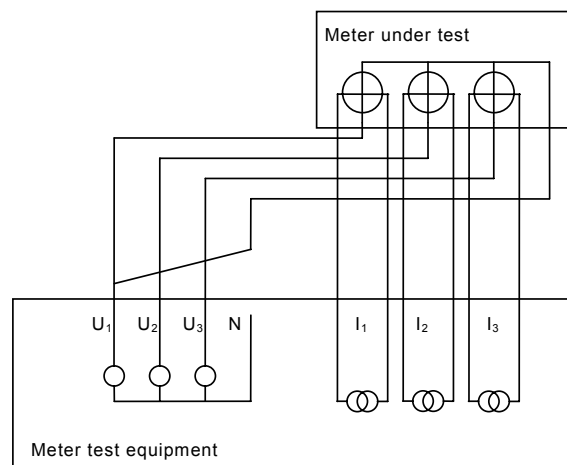

Figure 5. Set-up for earth fault test.

#### 6.4.12 Operation of auxiliary devices

Object of the test: To verify compliance with the provisions of 3.3.5.2 and Table 5 under conditions of operation of auxiliary devices. The operation of auxiliary devices shall be tested to ensure that they do not affect the metrological performance of the meter.

Test Procedure: In this test, the meter shall be operated at reference conditions and its error continuously monitored, while auxiliary devices such as communication devices, relays and other I/O circuits are operated.

Allowed effects: The functionality of the meter shall not be impaired and the error shift due to the operation of the auxiliary devices shall always be less than 1/10 of the base m.p.e..

Mandatory testpoints:  $I_{tr}$  and  $I_{max}$  at PF = 1.

### 6.4.13 Mechanical tests

#### 6.4.13.1 Vibrations

Applicable standards: IEC 60068-2-47, IEC 60068-2-64.

Object of the test: To verify compliance with the provisions of 3.3.5.2 and Table 5 under conditions of vibrations.

Test procedure in brief: The meter shall, in turn, be tested in three, mutually perpendicular axes whilst mounted on a rigid fixture by its normal mounting means.

The meter shall normally be mounted so that the gravitational force acts in the same direction as it would in normal use. Where the effect of gravitational force is not important the meter may be mounted in any position.

Test severity:

Total frequency range	10 – 150 Hz
Total r.m.s. level	7 m·s <sup>-2</sup>
ASD level 10-20 Hz	1 m <sup>2</sup> ·s <sup>-3</sup>
ASD level 20-150 Hz	-3 dB/octave
Duration per axis:	at least 2 minutes.

Allowed effects: After the test, the function of the meter shall not be impaired and the error shift, at 10  $I_{tr}$ , shall not exceed the limit of error shift listed in Table 5.

Mandatory testpoints: 10  $I_{tr}$ , PF = 1.

#### 6.4.13.2 Shock

Applicable standard: IEC 60068-2-27.

Object of the test: To verify compliance with the provisions of 3.3.5.2 and Table 5 under conditions of shock.

Test procedure in brief: The meter is subjected to non-repetitive shocks of standard pulse shapes with specified peak acceleration and duration. During the test, the meter shall not be operational and it shall be fastened to a fixture or to the shock-testing machine.

Test severity: Pulse shape: Half-sine  
Peak acceleration: 30  $g_n$  (300 ms<sup>-2</sup>)  
Pulse duration: 18 ms

Allowed effects: After the test, the function of the meter shall not be impaired and the error shift, at 10  $I_{tr}$ , shall not exceed the limit of error shift listed in Table 5.

Mandatory testpoints: 10  $I_{tr}$ , PF = 1.

### 6.4.14 Protection against solar radiation

Applicable standard: ISO 4892-3

The object of the test: To verify compliance with the requirements of 3.5, 3.6.1, 3.7.1 and 3.3.5.2 regarding protection against solar radiation. For outdoor meters only.

Test conditions: Meter in non-operating condition;

Test apparatus: Lamp type/wavelength: UVA 340

Black panel thermometer

Light meter

Cycling rig with a condensation cycle to comply with the parameters in the test conditions

Test conditions: Meter in non-operating condition

Test Cycle (12 h cycle)	Lamp type	Spectral irradiance	Black panel temperature
8 h dry	UVA 340	0.76 W/m <sup>2</sup> /nm at 340 nm	60 ±3 °C
4 h condensation		Light off	50 ±3 °C

Test Procedure in brief: Partially mask a section of the meter for later comparison. Expose the meter to artificial radiation and weathering in accordance with ISO 4892-3 for a period of 66 days (132 cycles) and in accordance with the test conditions above.

After the test the meter shall be visually inspected and a functional test shall be performed. The appearance and, in particular, the legibility of markings and displays shall not be altered. Any means of protection of the metrological properties, such as the case and sealing, shall not be affected. The function of the meter shall not be impaired.

#### 6.4.15 Protection against ingress of dust

Applicable standard: IEC 60529

The object of the test: To verify compliance with the provisions of 3.3.5.2 and Table 5 regarding protection against the ingress of dust.

Test conditions: For outdoor meters only;

Reference conditions;

IP 5x rating;

Category 2 enclosure.

Test procedure in brief: After the test the interior of the meter shall be visually inspected and a functional test shall be performed.

Allowed effects: The talcum powder or other dust used in the test shall not have accumulated in a quantity or location such that it could interfere with the correct operation of the equipment or impair safety. No dust shall deposit where it could lead to tracking along the creepage distances. The function of the meter shall not be impaired.

#### 6.4.16 Climatic tests

##### 6.4.16.1 Extreme temperatures - dry heat

Applicable standards: IEC 60068-2-2, IEC 60068-3-1.

Object of the test: To verify compliance with the provisions of 3.3.5.2 and Table 5 under conditions of dry heat.

Test procedure in brief: The test consists of exposure to the specified high temperature under "free air" conditions for 2 hours (beginning from when the temperature of the meter is stable), with the meter in a non-operating state.

The change of temperature shall not exceed 1 °C/min during heating up and cooling down.

The absolute humidity of the test atmosphere shall not exceed 20 g/m<sup>3</sup>.

Test severity: The test shall be performed at a standard temperature one step higher than the upper temperature limit specified for the meter.

Possible temperatures: 55 70 85 °C

Allowed effects: After the test, the function of the meter shall not be impaired and the error shift shall not exceed the limit of error shift listed in Table 5.

Mandatory testpoints: 10 I<sub>tr</sub>, PF = 1.

##### 6.4.16.2 Extreme temperatures - cold

Applicable standards: IEC 60068-2-1, IEC 60068-3-1.

Object of the test: To verify compliance with the provisions of 3.3.5.2 and Table 5 under conditions of low temperatures.

Test procedure in brief:	The test consists of exposure to the specified low temperature under “free air” conditions for 2 hours (beginning from the time when the temperature of the meter is stable) with the meter in a non-operating state.  The change of temperature shall not exceed 1 °C/min during heating up and cooling down.
Test severity:	The test shall be performed at a standard temperature one step lower than the lower temperature limit specified for the meter.
Possible temperatures:	-25     -40     -55 <sup>(1)</sup> °C
Allowed effects:	After the test, the function of the meter shall not be impaired and the error shift shall not exceed the limit of error shift listed in Table 5.
Mandatory testpoints:	10 I <sub>tr</sub> , PF = 1.

(1) If specified lower temperature limit is -55°C, then this test shall be performed at -55°C.

#### 6.4.16.3 Damp heat, steady-state (non-condensing), for humidity class H1

Applicable standards:	IEC 60068-2-78, IEC 60068-3-4.
Object of the test:	To verify compliance with the provisions in Table 4, 3.3.5.2 and Table 5 under conditions of high humidity and constant temperature. For meters that are specified for enclosed locations where the meters are not subjected to condensed water, precipitation, or ice formations (H1).
Test procedure in brief:	The test consists of exposure to the specified high level temperature and the specified constant relative humidity for a certain fixed time defined by the severity level. The meter shall be handled such that no condensation of water occurs on it.
Test conditions:	Voltage and auxiliary circuits energized with reference voltage;  Without any current in the current circuits.
Test severity:	Temperature: 30 °C  Humidity: 85 %  Duration: 2 days
Allowed effects:	During the test no significant fault shall occur. Immediately after the test the meter shall operate correctly and comply with the accuracy requirements of Table 4.  24 hours after the test the meter shall be submitted to a functional test during which it shall be demonstrated to operate correctly. There shall be no evidence of any mechanical damage or corrosion which may affect the functional properties of the meter.

#### 6.4.16.4 Damp heat, cyclic (condensing) for humidity class H2 and H3

Applicable standards:	IEC 60068-2-30, IEC 60068-3-4.
Object of the test:	To verify compliance with the provisions in Table 4, 3.3.5.2 and Table 5 under conditions of high humidity and temperature variations. This test applies to meters with a humidity class specification either for enclosed locations where meters can be subjected to condensed water or for open locations (humidity classes H2 and H3).
Test procedure in brief:	The test consists of exposure to cyclic temperature variation between 25 °C and the temperature specified as the upper temperature according to the test severities below, whilst maintaining the relative humidity above 95 % during the temperature change and low temperature phases, and at 93 % during the upper temperature phases. Condensation should occur on the meter during the temperature rise.  The 24 h cycle consists of: <ol style="list-style-type: none"> <li>1) temperature rise during 3 h</li> <li>2) temperature maintained at upper value until 12 h from the start of the cycle</li> <li>3) temperature reduced to lower value within 3 h to 6 h, the rate of fall during the first hour and a half being such that the lower value would be reached in 3 h</li> <li>4) temperature maintained at lower value until the 24 h cycle is completed.</li> </ol>

The stabilizing period before and recovery after the cyclic exposure shall be such that all parts of the meter are within 3 °C of their final temperature.

Test conditions: Voltage and auxiliary circuits energized with reference voltage;  
Without any current in the current circuits.  
Mounting position according to manufacturer’s specification

Test severities: Meters with a humidity class specification for enclosed locations where meters can be subjected to condensed water shall be tested at severity level 1. Meters with a humidity class specification for open locations shall be tested at severity level 2.

Specified Humidity Class:	H2	H3
Severity levels:	1	2
Upper temperature (°C):	40	55
Duration (cycles):	2	2

Allowed effects: During the test no significant fault shall occur.  
Immediately after the test the meter shall operate correctly and comply with the accuracy requirements of Table 4.  
24 hours after the test the meter shall be submitted to a functional test during which it shall be demonstrated to operate correctly. There shall be no evidence of any mechanical damage or corrosion which may affect the functional properties of the meter.

**6.4.16.5 Water test**

Applicable standards: IEC 60068-2-18, IEC 60512-14-7, IEC 60529  
Object of the test: To verify compliance with the provisions in 3.3.5.2 and Table 5 under conditions of rain and water splashes. The test is applicable to meters that are specified for open locations (H3).  
Test procedure in brief: The meter is mounted on an appropriate fixture and is subjected to impacting water generated from either an oscillating tube or a spray nozzle used to simulate spraying or splashing water.  
Test conditions: The meter shall be in functional mode during the test  
Flow rate (per nozzle): 0.07 L/min  
Duration: 10 min  
Angle of inclination: 0 ° and 180 °  
Allowed effects: During the test no significant fault shall occur.

Immediately after the test the meter shall operate correctly and comply with the accuracy requirements of Table 2.  
24 hours after the test the meter shall be submitted to a functional test during which it shall be demonstrated to operate correctly and comply with the accuracy requirements of Table 2. There shall be no evidence of any mechanical damage or corrosion which may affect the functional properties of the meter.

**6.4.17 Durability test**

Applicable standard(s): IEC 62059-32-1 (draft), IEC 60068-2-2.  
Object of the test: To verify compliance with the provisions in 3.8 and Table 5 for durability.  
Test procedure in brief: The meter shall be exposed to an elevated temperature under the specified test conditions and for the specified duration. The meter shall be operational throughout the test under the conditions specified below.  
The test procedure consists of three main steps:  
1) Initial error measurement.

Formatted: Heading 3  
Formatted: Bullets and Numbering  
Formatted: PARAGRAPH, Indent: Left: 0 cm, Hanging: 3.75 cm, Tabs: 3.75 cm, Left

- 2) Exposure to elevated temperature with intermediate error measurements. The error measured during the test shall comply with the limits of error given below in allowed effects. The error shall be measured, at least, at the end of the test.
- 3) Final error measurement to check compliance with the limits given in Table 5.

Test conditions: Elevated temperature according to IEC 60068-2-2 as follows:

Test Be:	Dry heat for heat-dissipating specimens with gradual change of temperature that are required to be powered throughout the test.
Air velocity:	Low preferred
Temperature:	Upper temperature limit specified for the meter.
Duration:	1000 hours <sup>(1)</sup>

Formatted: TABLE-cell, Tabs: Not at 3.75 cm  
Formatted Table  
Formatted: TABLE-cell, Tabs: Not at 3.75 cm  
Formatted: TABLE-cell, Tabs: Not at 3.75 cm

Meter operating conditions for elevated temperature test:

Voltage:	1.1 $U_{nom}$
Current:	$I_{max}$ <sup>(1)</sup>
Power factor:	Unity

Formatted: Superscript  
Formatted: PARAGRAPH, Indent: Left: 3.75 cm, Tabs: 3.75 cm, Left  
Formatted: Font: Not Italic  
Formatted: Superscript

Note (1): To facilitate testing, a lower current and proportionally longer duration may be applied. The current may be lowered at most to 0.8  $I_{max}$  (corresponding to a duration of 1250 hours).

Formatted: NOTE, Indent: Left: 3.75 cm

Allowed effects: In addition to checking that the error shift complies with the limits given in Table 5, the meter shall comply with the following error limits during the test.

Formatted: PARAGRAPH, Indent: Left: 0 cm, Hanging: 3.75 cm, Tabs: 3.75 cm, Left

Method A, using a reference standard meter:	$e_{max} = 2\sqrt{e_o^2 + e_U^2 + e_T^2}$
Method A, using a reference meter of the same type as the meter under test	$e_{max} = 2\sqrt{(e_o + e_r)^2 + e_T^2}$
Method B, using a stable load:	$e_{max} = 2\sqrt{e_o^2 + e_U^2 + e_T^2 + 1^2}$

Formatted Table  
Formatted: Lowered by 6 pt

Where:

- $e_o$  is the base m.p.e. at the test load
- $e_U$  is the limit of error shift due to voltage variation at the test load
- $e_T$  is the limit of error shift due to temperature variation at the test load
- $e_r$  is the absolute value of the error of the reference meter at the test load

Mandatory testpoints: For initial and final measurement, the voltage shall be  $U_{nom}$ , with the following testpoints:  $I_{10}$ ,  $10 I_{tr}$ , and  $I_{max}$  at PF = 1.

Formatted: PARAGRAPH, Indent: Left: 0 cm, Hanging: 3.75 cm, Tabs: 3.75 cm, Left

## 7 Examination for conformity with type

An examination for conformity with type should determine whether a meter complies with all requirements in section 3, and whether documentation supplied by the manufacturer complies with the requirements in section 4.1.

A meter may only be deemed to have passed examination for conformity with type if the results of any type tests comply with the requirements given in section 3. The measurement uncertainty must be small enough to allow clear discrimination between a pass result and a fail result. In particular, an uncertainty less than one fifth the maximum permissible error given for the corresponding test point must be obtained for tests described in section 6.2, unless otherwise specified in the relevant test description.

The scope of the tests performed and test severities used shall be consistent with the manufacturer's specifications and with the requirements of section 3.

## 8 VERIFICATION

### 8.1 General

Verification may be carried out either individually or statistically. In all cases meters shall conform to the requirements of this Recommendation. As noted in 3.3.3, individual national authorities may specify the base maximum permissible

Deleted: R46CD5 (30 July 2010)



errors for subsequent verification and in-service inspections. The following minimum programme applies to the initial verification of all meters, whether verified individually or statistically, and to re-verification of meters which have been repaired or otherwise changed. For individual or statistical re-verification of meters that have not been repaired or otherwise changed, the programme may be modified and further reduced. The exact requirements shall be specified by the national authority.

## 8.2 Testing

### 8.2.1 Calibration status

Check that the test system used has sufficient accuracy to verify the meters under test, and that the calibration is valid.

### 8.2.2 Conformity check

Check that the instrument is manufactured in conformity with the type approval documentation.

### 8.2.3 Warming-up

It may be necessary to warm the meter up before full operation. The length of the warming-up period depends on the actual type of instrument and shall be determined in advance. During the test for initial intrinsic error the meter shall be allowed to stabilize at each current level before measurements for a period, no longer than 5 minutes, to be nominated by the manufacturer. The order of the testpoints shall be from lowest current to highest current and then from highest current to lowest current. For each testpoint, the resulting error shall be the mean of these measurements. For  $I_{\max}$ , the maximum measurement time shall be 10 minutes including stabilizing time.

### 8.2.4 Minimum test programme

The minimum programme consists of:

- No-load check
- Starting current check
- Current dependence
- Check of the register

#### 8.2.4.1 No-load check

For this test, there shall be no current in the current circuit. The test shall be performed at  $U_{\text{nom}}$ .

For meters with a test output, the output of the meter shall not produce more than one pulse. For an electromechanical meter, the rotor of the meter shall not make a complete revolution.

The minimum test period  $\Delta t$  shall be

$$\Delta t \geq \frac{1000}{k \cdot b \cdot U_{\text{nom}} \cdot I_{\text{min}}} \text{ hours, where}$$

$k$  is the number of pulses emitted by the output device of the meter per kilowatt-hour (imp/kW·h) or the number of revolutions per kilowatt-hour (rev/kW·h);

$b$  is the base maximum permissible error at  $I_{\text{min}}$ ;

the nominal voltage  $U_{\text{nom}}$  is expressed in volts; and

the minimum current  $I_{\text{min}}$  is expressed in amperes

A meter with more than one connection mode shall be tested in all modes. However, if the test is made *in-situ* on an installed meter, only the actual mode of connection need be tested.

For transformer-operated meters with primary rated registers where the value of  $k$  (and possibly  $U_{\text{nom}}$ ) are given as primary side values, the constant  $k$  (and  $U_{\text{nom}}$ ) shall be recalculated to correspond to secondary side values (of voltage and current)..

#### 8.2.4.2 Starting current check

The test is performed at  $I_{\text{st}}$  and unity power factor. For initial verification of meters produced from a continuously operating process resulting in a large number of identical units, it is sufficient for the error curve from 0 to  $I_{\text{min}}$  to be recorded on a sample batch every 3 months for the particular meter type. For initial verification of meters produced by other means, it will be sufficient if the meter is observed to run continuously when the starting current is applied. A meter with more than one connection mode shall be tested in all modes. However, if the test is made *in-situ* on an installed meter, only the actual mode of connection need be tested.

### 8.2.4.3 Current dependence

Meters shall comply with the accuracy requirements of Table 2. These shall be checked at the following currents:

- $I_{\min}$ , PF = 1;
- $I_{tr}$ , PF = 1;
- $I_{tr}$ , PF = 0.5 inductive;
- $10 I_{tr}$ , PF = 1;
- $10 I_{tr}$ , PF = 0.5 inductive;
- $I_{\max}$ , PF = 1;
- $I_{\max}$ , PF = 0.5 inductive.

In the case of three-phase meters with an alternative single-phase connection mode or which are being used as two-phase meters, the single-phase load test shall be performed separately for each phase at:

- $10 I_{tr}$ , PF = 1 and
- $10 I_{tr}$ , PF = 0.5 inductive.

### 8.2.4.4 Check of the register

If test (pulse) outputs are used for tests of accuracy requirements, a test must be performed to ensure that the relation between the basic energy register and the relevant test output(s) complies with that specified by the manufacturer.

The test shall be performed by passing a quantity of energy  $E$  through the meter, where  $E$  is at least:

$$E_{\min} = \frac{R \cdot 10}{\text{base maximum permissible error(\%)}}$$

where  $R$  is the apparent resolution of the basic energy register.

The energy put through the meter shall be calculated using the number of pulses from the test output; the relative difference between this energy and the energy registered shall be determined. This relative difference must not be greater than one tenth of the base maximum permissible error.

The test shall be performed at a single arbitrary current  $I \geq I_{tr}$ .

### 8.2.5 Sealing

If there are no seals on the meter (e.g. because they have not yet been applied or because they have been removed during verification testing), the meter shall be sealed in accordance with the requirements specified by national authorities.

## 8.3 Reference conditions for initial and subsequent verifications in a laboratory

**Table 16 Reference conditions and their tolerances for initial and subsequent verification**

Quantity	Reference conditions	Tolerance
Voltage(s)	$U_{\text{nom}}$	$\pm 2 \%$
Ambient temperature	23°C	$\pm 5^\circ\text{C}$
Frequency	$f_{\text{nom}}$	$\pm 0.5 \%$
Wave-form	Sinusoidal	$d \leq 2 \%$
Magnetic induction of external origin at reference frequency	0 T	$B \leq 0.1 \text{ mT}$
Electromagnetic RF fields 30 kHz - 6 GHz	0 V/m	$< 2 \text{ V/m}$
Operating position for instruments sensitive to position	Mounting as stated by manufacturer	$\pm 3.0^\circ$
Phase sequence for poly-phase meters	L1, L2, L3	-
Load balance	Equal current in all current circuits	$\pm 5 \%$ and $\pm 5^\circ$

**Table 17 Load conditions and their tolerances in tests for initial and subsequent verification**

Current(s)	Current range of device under test	Class A,B: $\pm 10\%$ Class C,D: $\pm 10\%$
Power factor	Power factor range of device under test	current to voltage phase difference $\pm 5^\circ$

#### 8.4 Additional requirements for statistical verifications

This section contains additional requirements for verification on a statistical basis.

Note: National authorities shall determine whether the use of statistical methods is permitted.

##### 8.4.1 Lot

A lot shall consist of meters with homogeneous characteristics. All meters that comprise the lot shall correspond to the same type approval, and shall have the same year of manufacture.

##### 8.4.2 Samples

Samples shall be randomly taken from a lot.

##### 8.4.3 Statistical testing

The statistical control shall be based on attributes. The sampling system shall ensure:

- An Acceptance Quality Level (AQL) of not more than 1%; and
- A Limiting Quality (LQ) of not more than 7%.

The AQL is the maximum percentage of non-conforming items in a lot at which the lot has a probability of 95% to be accepted.

The LQ is the percentage of non-conforming items in a lot at which the lot has a maximum probability of 5% to be accepted.

Note: These requirements allow for substantial freedom in the verification program. Examples are given below based on a lot of 1000 meters.

Number of meters tested	40	70	100	1000
Maximum number of non-conforming meters.	0	1	2	10

#### 8.5 Additional requirements for statistical in-service inspections

Guidance for in-service inspections of utility meters is now being drafted by OIML TC 3/SC 4 [6].

# Annex A Definitions Taken From Other References

(Mandatory)

## A.1 Note on application of definitions

This annex contains definitions, taken from other documents, which have been cited in the Terminology section of this Recommendation. Generic phrases should thus be understood as specific in their application to this Recommendation, in particular, the phrase ‘specifications and regulations’ should be interpreted to be limited to the contents of this Recommendation, and the terms ‘measuring instrument’ and ‘measuring system’ mean ‘electricity meter’.

## A.2 Definitions from VIM:2007 (3<sup>rd</sup> edition) [2]

### A.2.1 Maximum permissible error [4.26]

Extreme value of measurement error, with respect to a known reference quantity value, permitted by specifications or regulations for a given measurement, measuring instrument, or measuring system

Note 1: Usually, the term “maximum permissible errors” or “limits of error” is used where there are two extreme values.

Note 2: The term “tolerance” should not be used to designate ‘maximum permissible error’

### A.2.2 Rated operating condition [4.9]

Operating condition that must be fulfilled during measurement in order that a measuring instrument or measuring system perform as designed.

Note: Rated operating conditions generally specify intervals of values for a quantity being measured and for any influence quantity.

### A.2.3 Reference condition [4.11]

Operating condition prescribed for evaluating the performance of a measuring instrument or measuring system or for comparison of measurement results

Note 1 Reference operating conditions specify intervals of values of the measurand and of the influence quantities.

Note 2 In IEC 60050-300, item 311-06-02, the term “reference condition” refers to an operating condition under which the specified instrumental measurement uncertainty is the smallest possible.

### A.2.4 Accuracy class [4.25]

Class of measuring instruments or measuring systems that meet stated metrological requirements that are intended to keep measurement errors or instrumental uncertainties within specified limits under specified operating conditions

## A.3 Definitions from VIM:1993 (2<sup>nd</sup> edition) [3]

### A.3.1 Intrinsic Error [5.24]

Error of a measuring instrument, determined under reference conditions.

### A.3.2 Influence quantity [2.7]

Quantity that is not the measurand but that affects the results of the measurement

Guide Comment: The definition of influence quantity is understood to include values associated with measurement standards, reference materials and reference data upon which the result of a measurement may depend, as well as phenomena such as short-term measuring instrument fluctuations and quantities such as ambient temperature, barometric pressure and humidity.

[Note 2 from VIM:2007, 2.52 definition of influence quantity]: In the GUM [5], the concept ‘influence quantity’ is defined as in the second edition of the VIM, covering not only the quantities affecting the measuring system, as in the definition above, but also those quantities that affect the quantities actually measured. Also, in the GUM this concept is not restricted to direct measurements.

## Annex B Bibliography

(Informative)

Ref.	Standards and reference documents	Description	Cited <sup>†</sup>
[1]	OIML D 11 (2004) General Requirements for electronic measuring instruments	Guidance for establishing appropriate metrological performance testing requirements for influence quantities that may affect the measuring instruments covered by International Recommendations.	2
[2]	OIML V2-200 (2007), (ISO/IEC Guide 99) International Vocabulary of Metrology – Basic and General Concepts and Associated Terms (VIM)	Vocabulary, prepared by a joint working group consisting of experts appointed by BIPM, IEC, IFCC, ISO, IUPAC, IUPAP, and OIML	Annex A
[3]	International Vocabulary of Basic and General Terms in Metrology (VIM) (1993)	Vocabulary, prepared by a joint working group consisting of experts appointed by BIPM, IEC, IFCC, ISO, IUPAC, IUPAP, and OIML	Annex A
[4]	OIML V1 (2000) International vocabulary of terms in legal metrology (VIML)	The VIML includes only the concepts used in the field of legal metrology. These concepts concern the activities of the legal metrology service, the relevant documents, as well as other problems linked with this activity. Also included in this Vocabulary are certain concepts of a general character which have been drawn from the VIM.	[not cited]
[5]	OIML G 1-100 (2008), (GUM) Evaluation of measurement data - Guide to the expression of uncertainty in measurement.	This Guide establishes general rules for evaluating and expressing uncertainty in measurement that are intended to be applicable to a broad spectrum of measurements.	Annex C
[6]	OIML TC 3/SC 4, 2 <sup>nd</sup> committee draft, February 2006 Surveillance of utility meters in service on the basis of sampling inspections.		8.5
[7]	IEC 60060-1 (1989) High-voltage Test Techniques. Part 1: General Definitions and Test Requirements.		6.4.10.2
[8]	IEC 60060-1 (1989) High-voltage Test Techniques. Part 1: General Definitions and Test Requirements.		6.4.10.2
[9]	IEC 60068-2-1 (2007) Environmental testing. Part 2: Tests. Test A: Cold.		6.4.16.2
[10]	IEC 60068-2-2 (2007) Environmental testing. Part 2: Tests. Test B: Dry heat.		6.4.16.1
[11]	IEC 60068-2-5 (2003) Environmental testing - Part 2: Tests. Test Sa: Simulated solar radiation at ground level.		[not cited] Was for solar rad. test
[12]	IEC 60068-2-18 (2000) Environmental testing. Part 2- Test R and guidance: Water.	Provides methods of test applicable to products which, during transportation, storage or in service, may be subjected to falling drops, impacting water or immersion. The primary purpose of water tests is to verify the ability of enclosures, covers and seals	6.4.16.5

		to maintain components and equipment in good working order after and, when necessary, under a standardized dropfield or immersion in water. These tests are not corrosion tests and should not be considered and used as such. The effects of a large temperature difference between the water and the specimen, such as increased water ingress resulting from pressure changes, as well as thermal shock, are not simulated. Established water tests in other standards are not intended to simulate natural rainfall and their quoted intensities are too high to be adopted for that purpose. Therefore, in addition to the high-intensity severities, Test R includes an artificial rain test based upon natural conditions but not taking into account high wind speeds generally associated with natural rain. Guidance is given on the applicability of the tests and the severities to be selected.	
[13]	IEC 60068-2-27 Ed. 4.0 (2008) Environmental testing - Part 2-27: Tests - Test Ea and guidance: Shock		6.4.13.2
[14]	IEC 60068-2-30 (2005) Environmental testing. Part 2-30: Tests. Test Db: Damp heat, cyclic (12+12- hour cycle).	Determines the suitability of components, equipment and other articles for use and/or storage under conditions of high humidity when combined with cyclic temperature changes.	6.4.16.4
[15]	IEC 60068-2-32 (2003) Environmental Testing - Part 2-32: Tests - Tested: Free fall.		not cited
[16]	IEC 60068-2-47 (2005) Environmental testing - Part 2-47: Test - Mounting of specimens for vibration, impact and similar dynamic tests.	Provides methods of mounting components, and mounting requirements for equipment and other articles, for the families of dynamic tests in IEC 60068-2, that is impact (Test E), vibration (Test F) and acceleration, steady-state (Test G).	6.4.13.1
[17]	IEC 60068-2-64 (2008) Environmental testing - Part 2: Test methods - Test Fh: Vibration, broad- band random (digital control) and guidance.	Determines the ability to withstand specified severities of broad-band random vibration. Applies to specimens which may be subjected to vibration of a stochastic nature by transportation or operational environments, for example in aircraft, space vehicles and land vehicles.  Has the status of a basic safety publication in accordance with IEC Guide 104.	6.4.13.1
[18]	IEC 60068-2-78 (2001) Environmental testing - Part 2-78: Tests - Test Cab: Damp heat, steady state.	Provides a test method for determining the suitability of electrotechnical products, components or equipment for transportation, storage and use under conditions of high humidity. The test is primarily intended to permit the observation of the effect of high humidity at constant temperature without condensation on the specimen over a prescribed period.  This test provides a number of preferred severities of high temperature, high humidity and test duration. The test can be applied to both heat-dissipating and non-heat dissipating specimens. The test is applicable to small equipment or components as well as large equipment having complex interconnections with test equipment external to the chamber, requiring a set-up time which prevents the use of preheating and the maintenance of specified conditions during the installation period.	6.4.16.3
[19]	IEC 60068-3-1 (1974-01), Supplement A (1978-01): Environmental testing - Part 3: Background information - Section 1: Cold and dry heat tests	Gives background information for Tests A: Cold (IEC 68-2-1), and Tests B: Dry heat (IEC 68-2-2). Includes appendices on the effect of: chamber size on the surface temperature of a specimen when no forced air circulation is used; airflow on chamber conditions; on surface temperatures of test specimens; wire termination dimensions and material on surface temperature of a	6.4.16.1; 6.4.16.2

		component; measurements of temperature, air velocity and emission coefficient. Supplement A gives additional information for cases where temperature stability is not achieved during the test.	
[20]	IEC 60068-3-4 (2001) Environmental testing. Part 3-4- Supporting documentation and guidance - Damp heat tests.	Provides the necessary information to assist in preparing relevant specifications, such as standards for components or equipment, in order to select appropriate tests and test severities for specific products and, in some cases, specific types of application. The object of damp heat tests is to determine the ability of products to withstand the stresses occurring in a high relative humidity environment, with or without condensation, and with special regard to variations of electrical and mechanical characteristics. Damp heat tests may also be utilized to check the resistance of a specimen to some forms of corrosion attack.	6.4.16.3; 6.4.16.4
[21]	IEC 60512-14-7 (1997) Electromechanical components for electronic equipment - Basic testing procedures and measuring methods - Part 14: Sealing tests - Section 7: Test 14g: Impacting water.	Defines a standard test method to assess the effects of impacting water or specified fluid on electrical connecting devices.	6.4.16.5
[22]	IEC 60529 (2001), Corrigenda IEC 60529-cor1 (2003) and IEC 60529-cor2 (2007) Degrees of protection provided by enclosures (IP Code).	Applies to the classification of degrees of protection provided by enclosures for electrical equipment with a rated voltage not exceeding 72.5 kV.  Has the status of a basic safety publication in accordance with IEC Guide 104.	6.4.15; 6.4.16.5
[23]	IEC 61000-4-1 (2006) Electromagnetic compatibility (EMC) - Part 4-1: Testing and measurement techniques - Overview of IEC 61000-4 series.	Gives applicability assistance to the users and manufacturers of electrical and electronic equipment on EMC standards within the IEC 61000-4 series on testing and measurement techniques.  Provides general recommendations concerning the choice of relevant tests.	6.4.4
[24]	IEC 61000-4-2 (2008) Electromagnetic compatibility (EMC) - Part 4-2: Testing and measurement techniques - Electrostatic discharge immunity test.	Relates to the immunity requirements and test methods for electrical and electronic equipment subjected to static electricity discharges, from operators directly, and to adjacent objects. Additionally defines ranges of test levels which relate to different environmental and installation conditions and establishes test procedures. The object of this standard is to establish a common and reproducible basis for evaluating the performance of electrical and electronic equipment when subjected to electrostatic discharges. In addition, it includes electrostatic discharges which may occur from personnel to objects near vital equipment.	6.4.3
[25]	IEC 61000-4-3 (2008). Electromagnetic compatibility (EMC). Part 4-3: Testing and measurement techniques - Radiated, radio-frequency, electromagnetic field immunity test.	Applies to the immunity of electrical and electronic equipment to radiated electromagnetic energy. Establishes test levels and the required test procedures. Establishes a common reference for evaluating the performance of electrical and electronic equipment when subjected to radio-frequency electromagnetic fields.	6.3.15.1
[26]	IEC 61000-4-4 (2004), Corrigenda IEC 61000-4-4-cor1 (2006) and IEC 61000- 4-4-cor2 (2007) Electromagnetic compatibility (EMC). Part 4-4: Testing and measurement techniques - Electrical fast transient/burst immunity tests.	Establishes a common and reproducible reference for evaluating the immunity of electrical and electronic equipment when subjected to electrical fast transient/burst on supply, signal, control and earth ports. The test method documented in this part of IEC 61000-4 describes a consistent method to assess the immunity of an equipment or system against a defined phenomenon.  The standard defines: – test voltage waveform; – range of test levels;	6.4.4

		<ul style="list-style-type: none"> <li>– test equipment;</li> <li>– verification procedures of test equipment;</li> <li>– test set-up; and</li> <li>– test procedure.</li> </ul> <p>The standard gives specifications for laboratory and post installation tests.</p>	
[27]	IEC 61000-4-5 (2005) Electromagnetic compatibility (EMC). Part 4-5: Testing and measurement techniques - Surge immunity test.	Relates to the immunity requirements, test methods, and range of recommended test levels for equipment to unidirectional surges caused by overvoltages from switching and lightning transients. Several test levels are defined which relate to different environment and installation conditions. These requirements are developed for and are applicable to electrical and electronic equipment. Establishes a common reference for evaluating the performance of equipment when subjected to high-energy disturbances on the power and inter-connection lines.	6.4.6; 6.4.10.2
[28]	IEC 61000-4-6 (2008) Electromagnetic compatibility (EMC) - Part 4-6: Testing and measurement techniques - Immunity to conducted disturbances, induced by radio-frequency fields.	Relates to the conducted immunity requirements of electrical and electronic equipment to electromagnetic disturbances coming from intended radio-frequency (RF) transmitters in the frequency range 9 kHz - 80 MHz. Equipment not having at least one conducting cable (such as mains supply, signal line or earth connection), which can couple the equipment to the disturbing RF fields is excluded. This standard does not intend to specify the tests to be applied to particular apparatus or systems. Its main aim is to give a general basic reference to all concerned product committees of the IEC. The product committees (or users and manufacturers of equipment) remain responsible for the appropriate choice of the test and the severity level to be applied to their equipment.	6.3.15.2
[29]	IEC 61000-4-8 (2001) Electromagnetic compatibility (EMC) - Part 4-8: Testing and measurement techniques - Power frequency magnetic field immunity test.	Relates to the immunity requirements of equipment, only under operational conditions, to magnetic disturbances at power frequency related to: <ul style="list-style-type: none"> <li>– residential and commercial locations;</li> <li>– industrial installations and power plants; and</li> <li>– medium voltage and high voltage sub-stations.</li> </ul>	6.3.14; 6.4.2
[30]	IEC 61000-4-11 (2004) Electromagnetic compatibility (EMC). Part 4-11: Testing and measurement techniques - Voltage dips, short interruptions and voltage variation immunity tests.	Defines the immunity test methods and range of preferred test levels for electrical and electronic equipment connected to low-voltage power supply networks for voltage dips, short interruptions, and voltage variations. This standard applies to electrical and electronic equipment having a rated input current not exceeding 16 A per phase, for connection to 50 Hz or 60 Hz AC networks. It does not apply to electrical and electronic equipment for connection to 400 Hz AC networks. Tests for these networks will be covered by future IEC standards. The object of this standard is to establish a common reference for evaluating the immunity of electrical and electronic equipment when subjected to voltage dips, short interruptions and voltage variations. It has the status of a Basic EMC Publication in accordance with IEC Guide 107.	6.4.5
[31]	IEC 61000-4-12 (2006) Electromagnetic compatibility (EMC) - Part 4-12: Testing and measurement techniques - Ring wave immunity test.		6.4.8
[32]	IEC 61000-4-13 Edition 1.1 2009-07 Electromagnetic compatibility (EMC) - Part 4-12: Testing and measurement techniques – Harmonics and		6.3.17



	interharmonics including mains signalling at a.c. power port, low frequency immunity tests.		
[33]	IEC 61000-6-1(2005) Electromagnetic compatibility (EMC) - Part 6-1: Generic standards - Immunity for residential, commercial and light-industrial environments.	Defines the immunity test requirements in relation to continuous and transient, conducted and radiated disturbances, including electrostatic discharges, for electrical and electronic apparatus intended for use in residential, commercial and light-industrial environment, and for which no dedicated product or product-family standard exists. Immunity requirements in the frequency range 0 kHz - 400 GHz are covered and are specified for each port considered. This standard applies to apparatus intended to be directly connected to a low-voltage public mains network or connected to a dedicated DC source which is intended to interface between the apparatus and the low-voltage public mains network.	6.4.5
[34]	IEC 61000-6-2 (2005) Electromagnetic compatibility (EMC) - Part 6-2: Generic standards - Immunity for industrial environments.	Applies to electrical and electronic apparatus intended for use in industrial environments, for which no dedicated product or product-family immunity standard exists. Immunity requirements in the frequency range 0 Hz - 400 GHz are covered, in relation to continuous and transient, conducted and radiated disturbances, including electrostatic discharges. Test requirements are specified for each port considered.  Apparatus intended to be used in industrial locations are characterized by the existence of one or more of the following: - a power network powered by a high or medium voltage power transformer dedicated to the supply of an installation feeding manufacturing or similar plant; - industrial, scientific and medical (ISM) apparatus; - heavy inductive or capacitive loads that are frequently switched; - currents and associated magnetic fields that are high.	6.4.5
[35]	IEC 62052-11 (2003) Electricity metering equipment (AC) - General requirements, tests and test conditions - Part 11: Metering equipment.		2
[36]	IEC 62053-21 (2003) Electricity metering equipment (a.c.) - Particular requirements - Part 21: Static meters for active energy (classes 1 and 2)		[not cited] Was 6.2.6.13
[37]	IEC 62053-22 (2003) Electricity metering equipment (a.c.) - Particular Requirements - Part 22: Static meters for active energy (classes 0,2 S and 0,5 S).		[not cited] Was 6.2.6.13
[38]	IEC 62053-52 (2005) Electricity metering equipment (AC) - Particular requirements - Part 52: Symbols.		3.5
[39]	<a href="#">IEC 62059-32-1 (draft 13/1449/CDV)</a> <a href="#">Electricity metering equipment – Dependability – Part 32-1: Durability – Testing of the stability of metrological characteristics by applying elevated temperature.</a>		6.4.17

Formatted: Bullets and Numbering

Deleted: R46CD5 (30 July 2010)

[40]	ISO 4892-3 Plastics – Methods of exposure to laboratory light sources – Part 3: Fluorescent UV lamps	6.4.14
------	---	--------

Formatted: Bullets and Numbering

† Editor’s Note: Citations, giving the location of the reference citation, will be removed from the final text.

Deleted: R46CD5 (30 July 2010)

# Annex C Estimation of Errors and Uncertainties

## (Informative)

### C.1 Estimate of overall maximum probable uncertainty

#### C.1.1 Estimation based on the requirements of this Recommendation

This Recommendation permits a base maximum permissible error plus an error shift caused by influence quantities. The actual error of a complying meter when in use could therefore exceed the base maximum permissible error. There is a need to estimate an overall maximum permissible error that indicates the largest error that can reasonably be attributed to a meter type that complies with this Recommendation. This entails estimating the uncertainty of measurement of an arbitrary meter at arbitrary conditions (within the rated operating conditions).

However, adding the base maximum permissible error and all error shifts algebraically would give a much too pessimistic estimate of the metering uncertainty, for two reasons. For an arbitrary set of influence factor values, some of the error shifts will be low and some will probably have opposite signs, tending to cancel each other out. Furthermore, the electricity meter is an integrating device, thus the errors caused by influence quantities will average out to some extent as the values of the influence factors vary over time.

If we make the following assumptions:

- The integrating effect may be ignored,
- None of the effects of the influence factors are correlated,
- The values of the influence quantities are more likely to be close to the reference values than to limits of the rated operated conditions,
- The influence quantities, and the effects of the influence factors, can be treated as Gaussian distributions, and thus a value of half the maximum permissible error shift can be used for the standard uncertainty,

Then the overall maximum permissible error (assuming a coverage factor of two corresponding to a coverage probability of approximately 95 %) can be estimated using the formula<sup>(1)</sup>:

$$u = 2 * \sqrt{\frac{u_{base}^2}{4} + \frac{u_{voltage}^2}{4} + \frac{u_{frequency}^2}{4} + \frac{u_{unbalance}^2}{4} + \frac{u_{harmonic}^2}{4} + \frac{u_{tilt}^2}{4} + \frac{u_{temperature}^2}{4}}$$

where:

$u_{base}$  is the base maximum permissible error;

$u_{voltage}$  is the maximum error shift permitted for voltage variation;

$u_{frequency}$  is the maximum error shift permitted for frequency variation;

$u_{unbalance}$  is the maximum error shift permitted for unbalance variation;

$u_{harmonics}$  is the maximum error shift permitted for the variation of harmonic content;

$u_{tilt}$  is the maximum error shift permitted for tilt;

$u_{temperature}$  is the maximum error shift permitted for temperature variation.

Note (1): This is line with the ISO Guide to the expression of uncertainty of measurement (GUM).

#### C.1.2 Estimation based on type test results and specific conditions

The overall maximum permissible error can also be estimated for a particular meter type using type test results. Type test results can often show a smaller variation than that required by this Recommendation, leading to an assured smaller value for the overall maximum permissible error. In such cases, the assumption of a Gaussian distribution may no longer be valid, and a rectangular distribution should be assumed for the effects of influence factors instead.

Thus, the overall maximum permissible error can then be estimated from a combination of test results using the formula:

$$u = 2 * \sqrt{\frac{u_{base}^2}{3} + \frac{u_{voltage}^2}{3} + \frac{u_{frequency}^2}{3} + \frac{u_{unbalance}^2}{3} + \frac{u_{harmonic}^2}{3} + \frac{u_{tilt}^2}{3} + \frac{u_{temperature}^2}{3}}$$

where:

[R46CD5A \(17 September 2010\)](#)

$u_{base}$  is the maximum error obtained in the test for base maximum error, algebraically added to the measurement uncertainty of the type test<sup>(2)</sup>;

$u_{voltage}$  is the maximum error shift obtained in the test for voltage variation, algebraically added to the measurement uncertainty of the type test;

$u_{frequency}$  is the maximum error shift obtained in the test for frequency variation, algebraically added to the measurement uncertainty of the type test;

$u_{unbalance}$  is the maximum error shift obtained in the test for unbalance variation, algebraically added to the measurement uncertainty of the type test;

$u_{harmonics}$  is the maximum error shift obtained in the test for variation of harmonic content, algebraically added to the measurement uncertainty of the type test;

$u_{tilt}$  is the maximum error shift obtained in the test for influence of tilt, algebraically added to the measurement uncertainty of the type test;

$u_{temperature}$  is the maximum error shift obtained in the test for temperature variation, algebraically added to the measurement uncertainty of the type test.

Note (2): The measurement uncertainty must be included in each component  $u_i$  of the overall maximum permissible error. Since one term is a known value and the other an uncertainty they cannot be treated as two uncorrelated statistical distributions, and must hence be added algebraically.

The effect of correlations between factors such as load profiles and ambient temperature variation on meter accuracy have not been included in the above calculations, but could be modelled in situations where appropriate.

# Annex D Legislative Matters

(Informative)

## D.1 Legislative considerations

It would be impractical to develop this Recommendation to fit each and every one of the wide variety of situations and meter applications which exist around the world. It is therefore inevitable that some issues may need to be addressed by national authorities or at a regional level.

One way in which this Recommendation seeks to provide an appropriate balance between flexibility and uniformity is by the provision of options for a number of conditions, such as:

- a) Nominal voltage
- b) Nominal frequency
- c) Rated temperature
- d) Level of protection from water and humidity
- e) Level of protection from impulse voltages
- f) Handling of energy flow direction

It should be noted that in some countries or regions, local legislation may also include specific requirements relating to matters such as:

- g) Electrical interface
- h) Mechanical interface and housing

It should also be noted that, while the maximum current is most often specified by the characteristics of the installation, the value of the transitional current and/or the ratio between the maximum current and the transitional current are important for end customers with low power consumption, since these customers could experience large relative metering errors if the load current is lower than the transitional current for a large part of the time. It is thus recommended that the values of  $I_{tr}$  and  $I_{max}$  be chosen from the table below:

**Table 18. Preferred current ranges**

Type of meter connection	Preferred values of $I_{tr}$ and $I_{max}$ (Amperes)	Other values of $I_{tr}$ and $I_{max}$ (Amperes)
Direct connection	Standard $I_{tr}$ values: 0.125, 0.25, 0.5, 1, 2, 3. Standard $I_{max}$ values: 10, 20, 40, 60, 80, 100, 120, 200, 320	Other $I_{tr}$ values: 0.75, 1.5, 2.5, 4, 5 Other $I_{max}$ values: 30, 50, 160
Connection through current transformer(s)	Standard $I_{tr}$ values: 0.05, 0.1, 0.25 Standard $I_{max}$ values: 1.2, 1.5, 2, 2.4, 3, 4, 6, 7.5, 10, 20	Other $I_{tr}$ values: 0.125 Other $I_{max}$ values: 3.75, 5

Note 1: The current range of transformer operated meters should be compatible with the current range of current transformers.

Note 2: The legislator may prescribe the maximum permissible  $I_{tr}$  value, prescribe a minimum current range, or a minimum ratio between  $I_{max}$  and  $I_{tr}$ . These can be prescribed as absolute values or values based on the typical power demand for certain types of customers etc.

### D.1.1 Choice of accuracy class

More accurate meters should be used when metering large flows of electricity in order to minimise the economic impact of unavoidable measurement errors. While class A meters may be acceptable for situations involving low energy consumption, higher class indices should be used when higher rates of energy consumption are involved.

The accuracy of the meter will be independent of the power grid characteristics for most meter connection modes; however, there may be a need for the evaluation of the influence of grid characteristics, especially for meters with higher class indices, in cases where there are underlying assumptions of grid symmetry and/or lack of leakage currents. It is possible that contributions to the overall meter error due to grid characteristics in such situations may be larger than contributions from the meter itself, especially at higher accuracy; it may therefore be appropriate to limit the use of connection modes of this type.

**D.1.2 Matters not covered by the scope of this document**

This document is limited to describing the relevant metrological requirements of an electricity meter and therefore omits certain matters which may or should be regulated by legislation, such as:

- a) EMC emissions
- b) Electrical safety and personal safety
- c) Security of communication protocols and further handling of measurement results

1	Scope .....	8
2	Terminology .....	8
2.1	Meters and their constituents .....	8
2.1.1	Electricity meter .....	8
2.1.2	Interval meter .....	8
2.1.3	Prepayment meter .....	8
2.1.4	Multi-tariff meter, multi-rate meter .....	8
2.1.5	Direct connected meter .....	8
2.1.6	Transformer operated meter .....	8
2.1.7	Electromechanical meter .....	8
2.1.8	Static meter .....	8
2.1.9	Measuring element .....	8
2.1.10	Current circuit .....	8
2.1.11	Voltage circuit .....	9
2.1.12	Indicating device, display .....	9
2.1.13	Register .....	9
2.1.14	Primary rated register .....	9
2.1.15	Register multiplier .....	9
2.1.16	Meter constant .....	9
2.1.17	Test output .....	9
2.1.18	Adjustment device .....	9
2.1.19	Auxiliary device .....	9
2.2	Metrological characteristics .....	9
2.2.1	Current ( $I$ ) .....	9
2.2.2	Starting current ( $I_{st}$ ) .....	9
2.2.3	Minimum current ( $I_{min}$ ) .....	9
2.2.4	Transitional current ( $I_{tr}$ ) .....	9
2.2.5	Maximum current ( $I_{max}$ ) .....	9
2.2.6	Voltage ( $U$ ) .....	9
2.2.7	Nominal voltage ( $U_{nom}$ ) .....	10
2.2.8	Frequency ( $f$ ) .....	10
2.2.9	Nominal frequency ( $f_{nom}$ ) .....	10
2.2.10	Harmonic .....	10
2.2.11	Sub-harmonic .....	10
2.2.12	Harmonic number .....	10
2.2.13	Distortion factor ( $d$ ) .....	10
2.2.14	Power factor (PF) .....	10
2.2.15	Active power .....	10
2.2.16	Active energy .....	10
2.2.17	Relative error (of indication) .....	10
2.2.18	Maximum permissible error (m.p.e.) .....	11
2.2.19	Base maximum permissible error .....	11
2.2.20	Maximum permissible error shift .....	11
2.2.21	Intrinsic error .....	11
2.2.22	Initial intrinsic error .....	11
2.2.23	Influence quantity .....	11
2.2.24	Influence factor .....	11

2.2.25	Disturbance	11
2.2.26	Rated operating condition	11
2.2.27	Reference condition	11
2.2.28	Accuracy class	11
2.2.29	Durability	11
2.2.30	Fault	11
2.2.31	Significant fault	12
2.2.32	Checking facility	12
2.2.33	Primary Register	12
3	Metrological Requirements	12
3.1	Units of measurement	12
3.2	Rated operating conditions	12
3.3	Accuracy requirements	14
3.3.1	General	14
3.3.2	Direction of energy flow	14
3.3.3	Maximum permissible errors	14
3.3.4	Allowed effects of influences	15
3.3.5	Allowed effects of disturbances	16
3.3.5.1	General	16
3.3.5.2	Disturbances	17
3.4	Timing requirements for interval and multi-tariff meters	18
3.5	Meter Markings	18
3.6	Protection of metrological properties	19
3.6.1	General	19
3.6.2	Software identification	19
3.6.3	Software protection	19
3.6.3.1	Prevention of misuse	19
3.6.3.2	Fraud protection	19
3.6.4	Parameter protection	20
3.6.5	Separation of electronic devices and sub-assemblies	20
3.6.6	Separation of software parts	21
3.6.7	Storage of data, transmission via communication systems	21
3.6.7.1	General	21
3.6.7.2	Automatic storing	21
3.6.7.3	Data transmission	22
3.6.7.4	Time stamp	22
3.6.8	Checking facility event record	22
3.7	Suitability for use	22
3.7.1	Readability of result	22
3.7.2	Testability	22
3.8	Durability	23
3.9	Presumption of compliance	23
4	Type approval	24
4.1	Documentation	24
4.2	Type definition	25
4.2.1	Type test sampling	25
4.3	Validation Procedure	25
5	Test program	26



6	Test procedures for type approval .....	26
6.1	Test conditions .....	26
6.2	Tests for maximum permissible error.....	27
6.2.1	Determination of initial intrinsic error.....	27
6.2.2	Continuous maximum current.....	28
6.2.3	Starting current.....	28
6.2.4	Test of no-load condition.....	29
6.2.5	Meter constants.....	29
6.3	Tests for influence quantities.....	29
6.3.1	General.....	29
6.3.2	Temperature dependence.....	29
6.3.3	Load balance.....	30
6.3.4	Voltage variation.....	30
6.3.5	Frequency variation.....	30
6.3.6	Harmonics in voltage and current.....	30
6.3.7	Tilt.....	32
6.3.8	Severe voltage variations.....	32
6.3.9	One or two phases interrupted.....	32
6.3.10	Sub-harmonics in the AC current circuit.....	33
6.3.11	Harmonics in the AC current circuit.....	34
6.3.12	Reversed phase sequence (any two phases interchanged).....	34
6.3.13	Continuous (DC) magnetic induction of external origin.....	35
6.3.14	Magnetic field (AC, power frequency) of external origin.....	35
6.3.15	Electromagnetic fields.....	35
	6.3.15.1 Radiated, radio frequency (RF), electromagnetic fields.....	35
	6.3.15.2 Immunity to Conducted Disturbances, Induced by Radiofrequency Fields.....	36
6.3.16	DC in the AC current circuit.....	37
6.3.17	High-order harmonics.....	37
6.4	Tests for disturbances.....	37
6.4.1	General instructions for disturbance tests.....	37
6.4.2	Magnetic field (AC, power frequency) of external origin.....	38
6.4.3	Electrostatic discharge.....	38
6.4.4	Fast transients.....	38
6.4.5	Voltage dips and interruptions.....	39
6.4.6	Radiated, radio frequency (RF), electromagnetic fields.....	40
6.4.7	Surges on AC mains power lines.....	40
6.4.8	Damped oscillatory waves immunity test.....	40
6.4.9	Short-time overcurrent.....	41
6.4.10	Impulse voltage.....	41
	6.4.10.1 General.....	41
	6.4.10.2 Impulse Voltage Test Procedure.....	42
	6.4.10.3 Impulse voltage tests for circuits and between circuits.....	42
	6.4.10.4 Impulse voltage test of electric circuits relative to earth.....	43
6.4.11	Earth fault.....	43
6.4.12	Operation of auxiliary devices.....	43
6.4.13	Mechanical tests.....	44
	6.4.13.1 Vibrations.....	44

	6.4.13.2 Shock .....	44
6.4.14	Protection against solar radiation.....	44
6.4.15	Protection against ingress of dust .....	45
6.4.16	Climatic tests .....	45
	6.4.16.1 Extreme temperatures - dry heat .....	45
	6.4.16.2 Extreme temperatures - cold .....	45
	6.4.16.3 Damp heat, steady-state (non-condensing), for humidity class H1.....	46
	6.4.16.4 Damp heat, cyclic (condensing) for humidity class H2 and H3 .....	46
	6.4.16.5 Water test .....	47
7	Examination for conformity with type.....	47
8	VERIFICATION .....	48
8.1	General .....	48
8.2	Testing.....	48
8.2.1	Calibration status .....	48
8.2.2	Conformity check .....	48
8.2.3	Warming-up.....	48
8.2.4	Minimum test programme .....	48
	8.2.4.1 No-load check .....	48
	8.2.4.2 Starting current check .....	49
	8.2.4.3 Current dependence.....	49
	8.2.4.4 Check of the register .....	49
8.2.5	Sealing .....	49
8.3	Reference conditions for initial and subsequent verifications in a laboratory .....	49
8.4	Additional requirements for statistical verifications.....	50
	8.4.1 Lot.....	50
	8.4.2 Samples.....	50
	8.4.3 Statistical testing.....	50
8.5	Additional requirements for statistical in-service inspections .....	50
Annex A	Definitions Taken From Other References .....	51
A.1	Note on application of definitions .....	51
A.2	Definitions from VIM:2007 (3 <sup>rd</sup> edition) [2] .....	51
	A.2.1 Maximum permissible error [4.26].....	51
	A.2.2 Rated operating condition [4.9] .....	51
	A.2.3 Reference condition [4.11] .....	51
	A.2.4 Accuracy class [4.25].....	51
A.3	Definitions from VIM:1993 (2 <sup>nd</sup> edition) [3].....	51
	A.3.1 Intrinsic Error [5.24].....	51
	A.3.2 Influence quantity [2.7] .....	51
Annex B	Bibliography.....	52
Annex C	Estimation of Errors and Uncertainties .....	57
C.1	Estimate of overall maximum probable uncertainty.....	57
	C.1.1 Estimation based on the requirements of this Recommendation .....	57
	C.1.2 Estimation based on type test results and specific conditions.....	57
Annex D	Legislative Matters .....	59
D.1	Legislative considerations .....	59
	D.1.1 Choice of accuracy class.....	59

D.1.2	Matters not covered by the scope of this document.....	60
-------	--	----